



Handrail Parts  
Custom Woodturnings  
Furniture Legs

3RD EDITION



Eldon Ives started woodworking at the age of 5 with his father in their backyard shop in San Leandro, California. His love for woodworking continued through high school.

In 1976 Eldon began working for Schoenstein & Co., a pipe organ company in San Francisco. There he learned the art of fine woodworking, making wood pipes, bellows and all aspects of organ building and installation.

**In January of 1980** Eldon and his family moved to Pleasant Grove, Utah, where he worked at a church pew business until 1982, when he began his own woodworking business in his garage. Soon, he expanded and moved into a shop in Orem, UT.

**In 1990** Ives Woodturning bought a copy lathe and began focusing on woodturning and handrail parts. The business moved into their own building in 1999 to expand their capacity for growth. Ives Woodturning has continued to expand and upgrade their facilities, **buying a second copy lathe in 1999 and a molder in 2002** to better facilitate the growing business.

**In 2006** Ives Woodturning upgraded their turning capacity by purchasing a fully **CNC lathe with fluting and spiral capacities.**

**Ives Woodturning sets the standard** for high quality products that are used by many quality builders and in home show homes. They are the preferred custom woodturning supplier to many custom cabinet makers and woodworking companies.

*Ives Woodturning is known for its service, quality products and fair prices.*



## **POLICIES:**

Ives Woodturning Inc. is not responsible for improper use or installation of its products. We do not warranty the safety or performance of our products. All parts are for interior use only, unless specifically ordered otherwise. Installation of these parts should be made by a qualified installer according to local or appropriate building codes. These codes should be strictly observed and use only the best and safest practices used when installing these parts.

## **TERMS:**

30 days net on pre-approved customers with good credit. COD for all others. Over due invoices may be turned over to a collection agency, and are subject to a 2% monthly or 24% annual finance charge. Returned checks are subject to a \$25.00 charge.

## **PRICES:**

All prices are subject to change without notice.

## **RETURNS:**

All standard items may be returned with prior approval from Ives Woodturning, Inc. We may charge a 25% restocking fee to cover re-stocking and handling. Returns must be in good original condition. Custom items may not be returned.

*Thank You For Your Business!*

# Index

Newel Posts & Balusters ..... 1-20  
 Handrail ..... 21  
 Bun Feet ..... 22-24  
 Furniture & Table Legs ..... 25-43  
 Fireplace Columns ..... 44  
 Fluted Table & Furniture Legs ..... 45  
 Spiral Turnings ..... 46

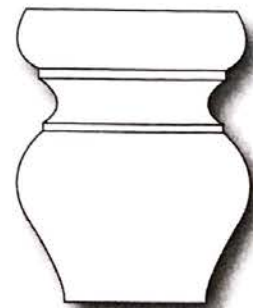
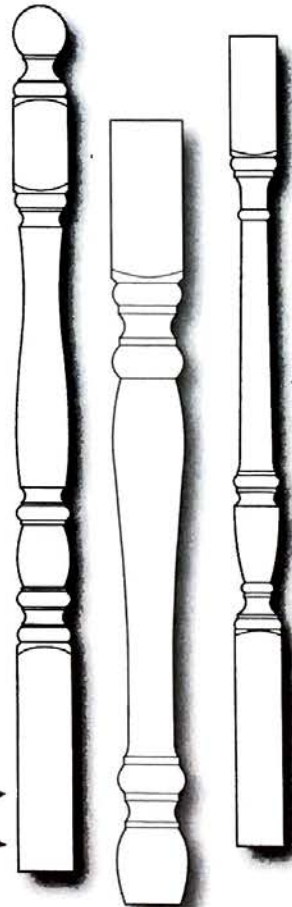

**We Now Offer  
Spiral Turnings  
On Selected Styles  
Call For Availability**

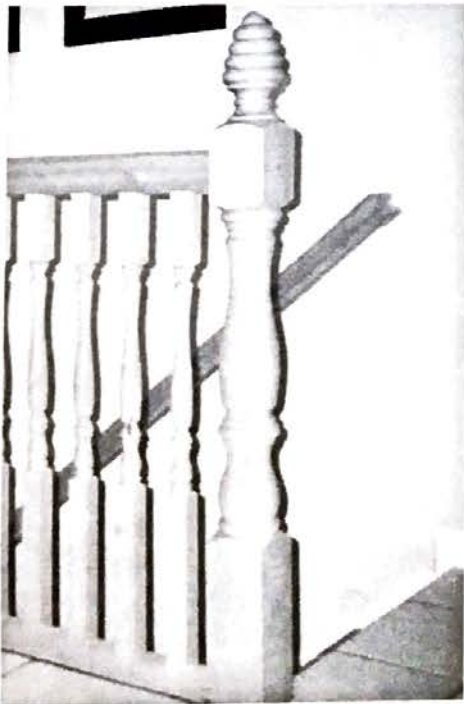
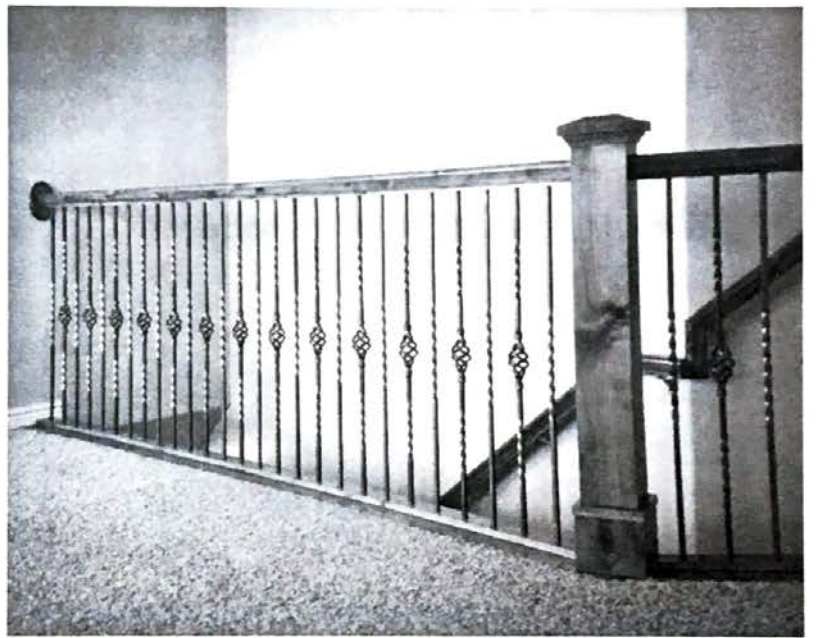

# Handrail Parts

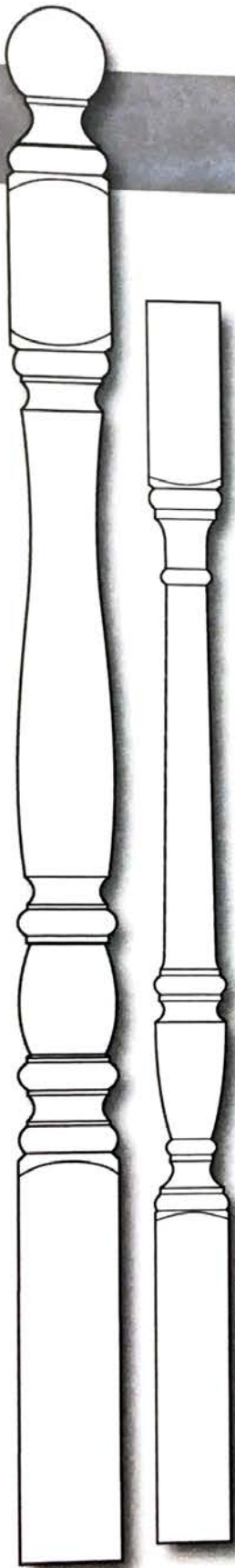

All Newel Posts & Balusters are available in a variety of lengths and sizes. If a size is not present in the illustrations, call Ives Woodturning, Inc. for availability.

Ives Woodturning, Inc. specializes in custom woodturnings so we can match your drawings, pictures, or examples.

Newel Posts are available with a variety of different tops: Ball, Egg, Button, Acorn, and Beehive. All Newel Posts can be fluted upon request for an additional charge.

Balusters are available with a dowel or square top.

All Handrail Parts are priced according to size and wood selection. Prices may vary depending on wood prices.



**Ball**



**Egg**



**Button**



**Acorn**

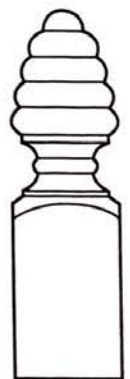

**Beehive**

## Craftsman style

5 1/8"

Box Newel, Pyramid Cap,  
Double Panel

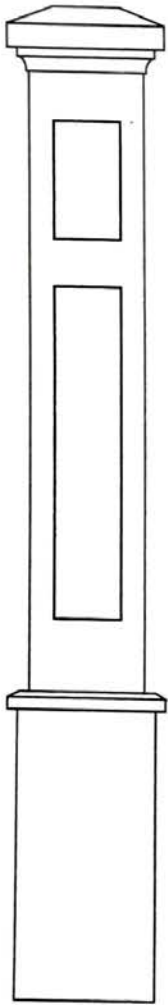

5 1/8"

Box Newel, Flat Cap,  
Double Panel With Arch

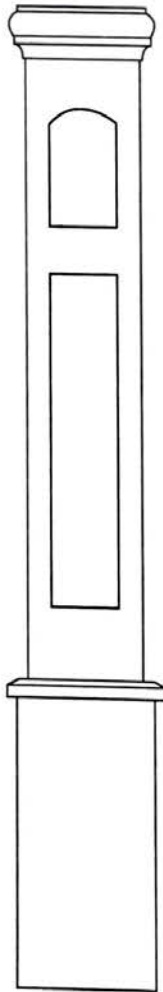

5 1/8"

Box Newel, Pyramid Cap,  
Single Panel

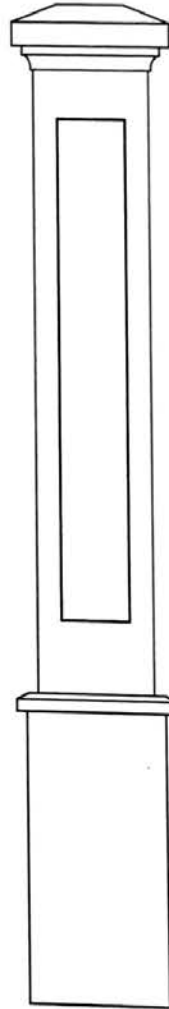

5 1/8"

Box Newel, Flat Cap,  
Single Panel With Arch

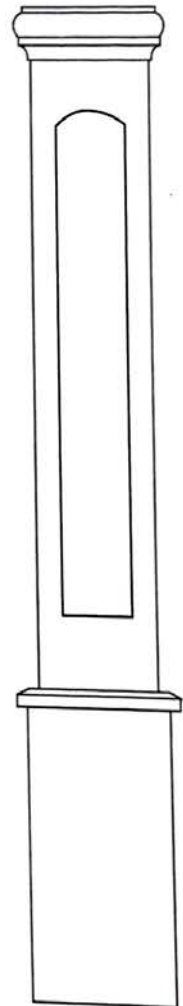

1/8 Scale  
1/8" = 1"

**craftsman style**  
Box Newel, Pyramid Cap,  
Double Panel  
1 3/4" Unturned Baluster

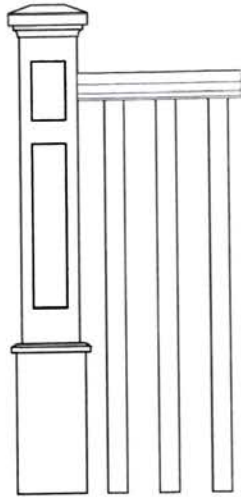

**craftsman style**  
Box Newel, Flat Cap  
Double Panel With Arch  
1 3/4" Unturned Baluster

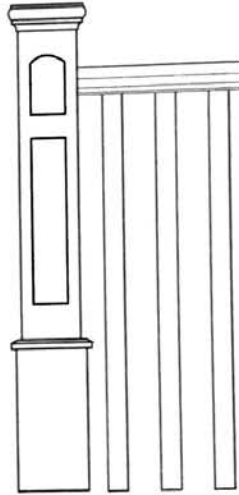

**craftsman style**  
Box Newel, Pyramid Cap,  
Single Panel  
1 3/4" Unturned Baluster

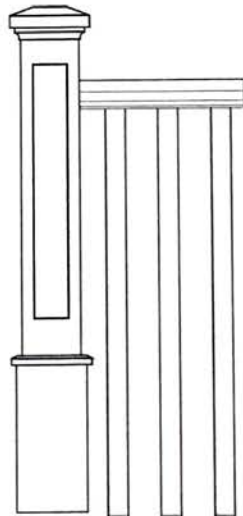

**craftsman style**  
Box Newel, Flat Cap  
Single Panel With Arch  
1 3/4" Unturned Baluster

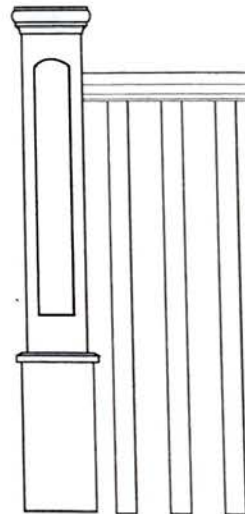

1/16 Scale  
1/16" = 1"



# french style #101

**3"**  
Ives French Style



**3"**  
French Style Long



**3 1/2"**  
French Style



**3 1/2"**  
Comm. French Style



**5"**  
French Style



**5 1/2"**  
French Style

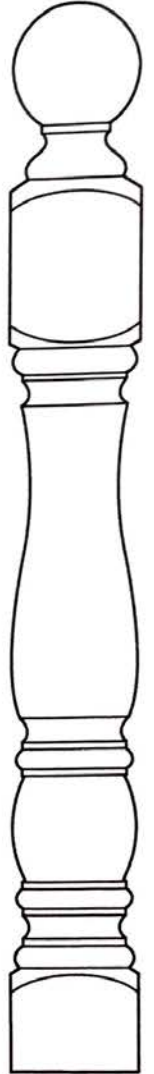

1/8 Scale  
1/8" = 1"

# french style #101

1 ¼"  
French  
#C201



1 ¼"  
French  
#201



1 ¾"  
French  
#201



1 ¾"  
French  
#C201



2 ¼"  
French  
#201



1/8 Scale  
1/8" = 1"

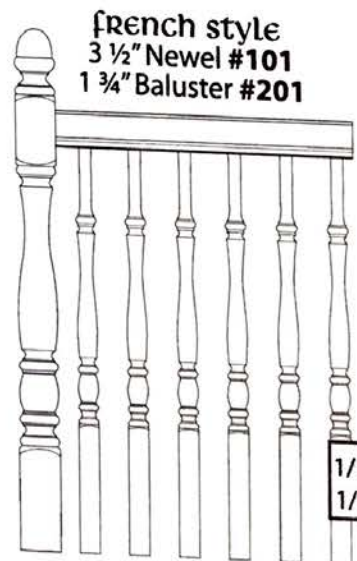
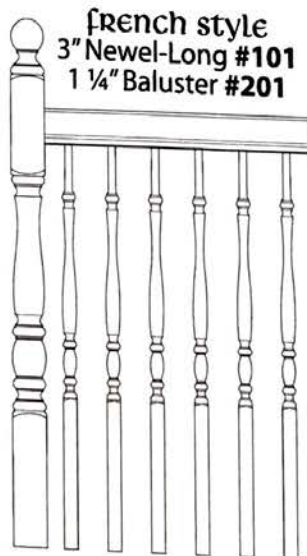
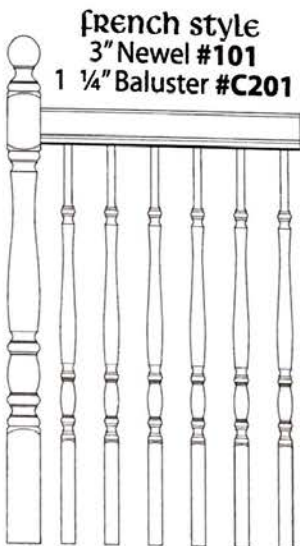

1/16 Scale  
1/16" = 1"

# french style #101

1 ¼"  
French  
#C201



1 ¼"  
French  
#201



1 ¾"  
French  
#201



1 ¾"  
French  
#C201



2 ¼"  
French  
#201



1/8 Scale  
1/8" = 1"

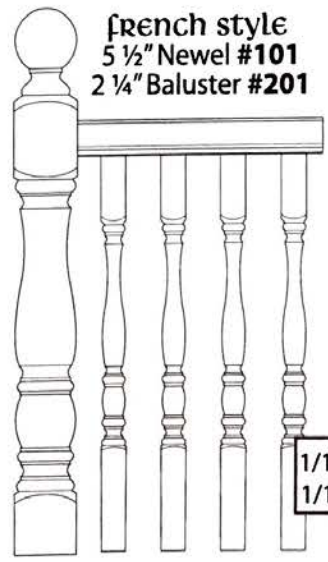
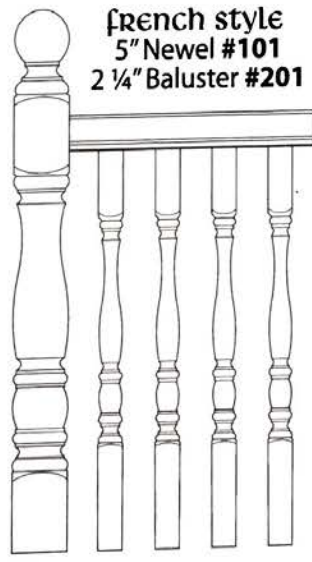
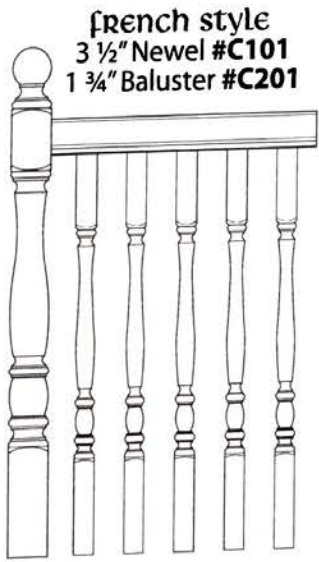

1/16 Scale  
1/16" = 1"

# italian style #105

3 1/2"



1 1/4"  
Italian  
#205

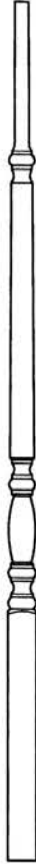

1 3/4"  
Italian  
#205



1 3/4"  
Italian  
#205



2 1/4"  
Italian  
#205



1/8 Scale  
1/8" = 1"

italian style  
3 1/2" Newel #105  
1 1/4" Baluster #205

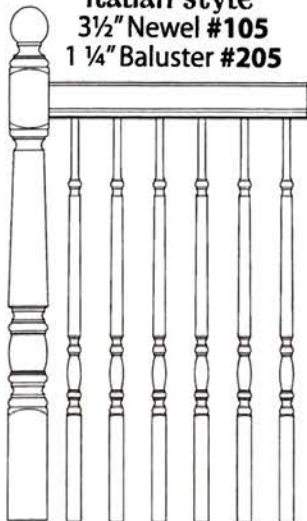

italian style  
3 1/2" Newel #105  
1 3/4" Baluster #205

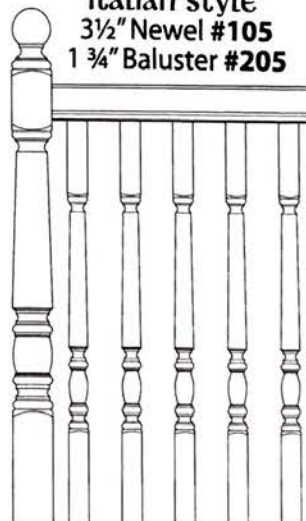

1/16 Scale  
1/16" = 1"

# cedar hills style #103

3 1/2"

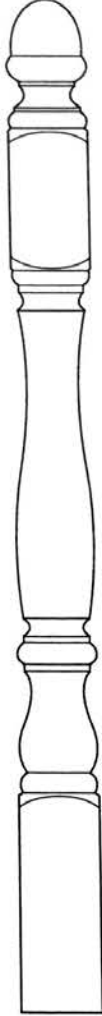

4 1/2"

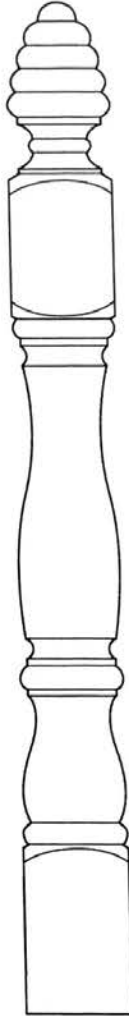

1 3/4"

Cedar Hills  
#203



1/8 Scale  
1/8" = 1"

cedar hills style  
3 1/2" Newel #103  
1 3/4" Baluster #203

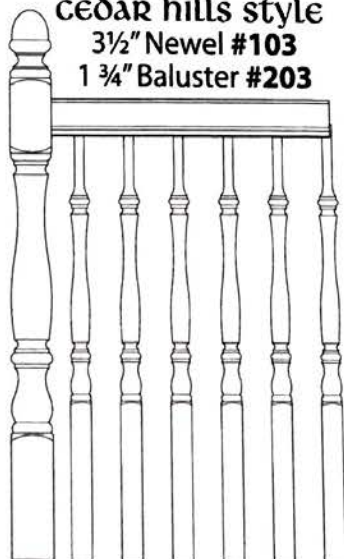

cedar hills style  
4 1/2" Newel #103  
1 3/4" Baluster #203

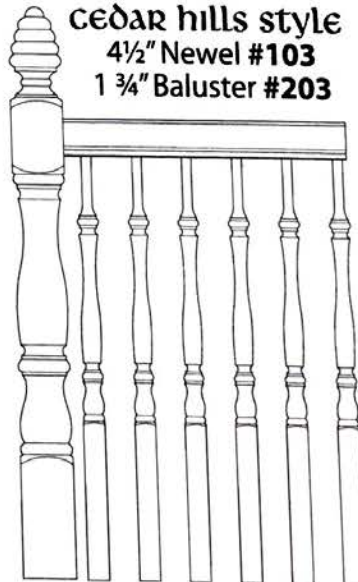

1/16 Scale  
1/16" = 1"

# classic style #102

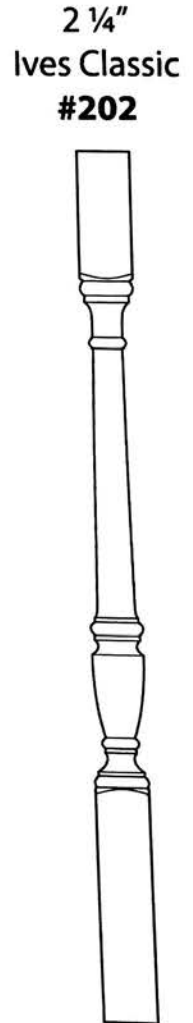
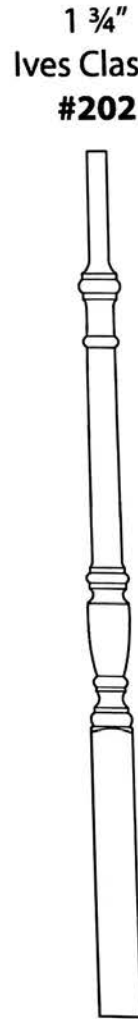
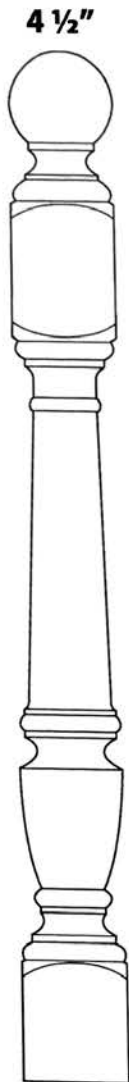
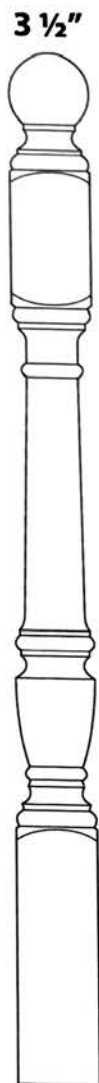
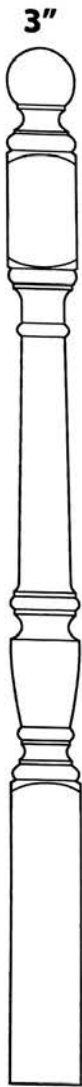

1/8 Scale  
1/8" = 1"

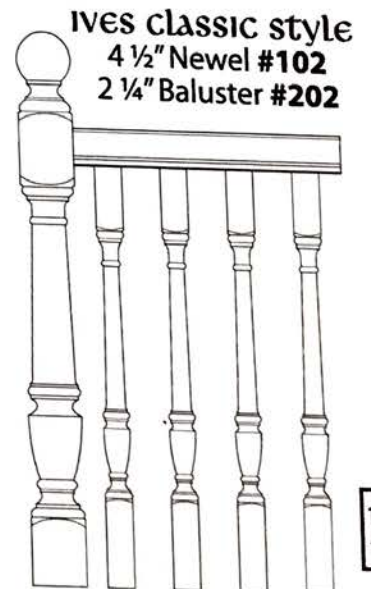
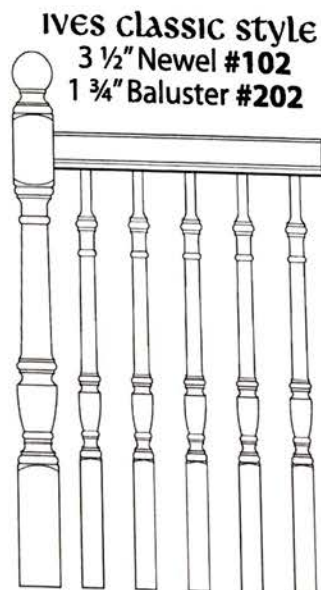
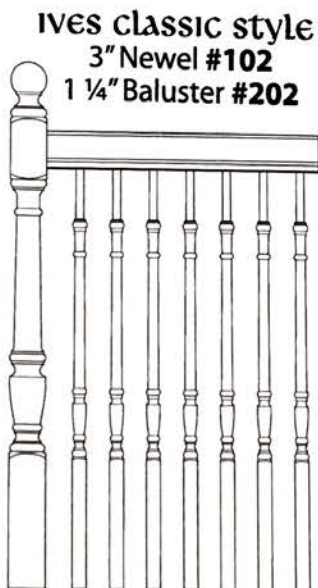

1/16 Scale  
1/16" = 1"

# springville style #109

3 1/2"



4 1/2"



1 3/4"  
Springville  
#209



2 1/4"  
Springville  
#209



1/8 Scale  
1/8" = 1"

springville style  
3 1/2" Newel #109  
1 3/4" Baluster #209

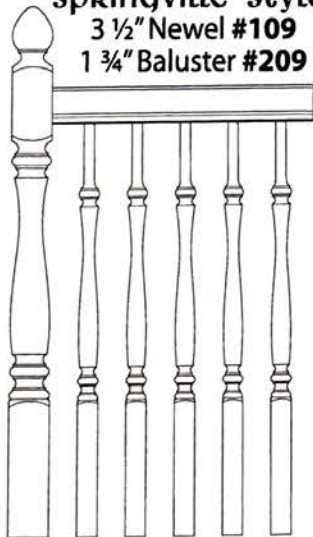

springville style  
4 1/2" Newel #109  
2 1/4" Baluster #209

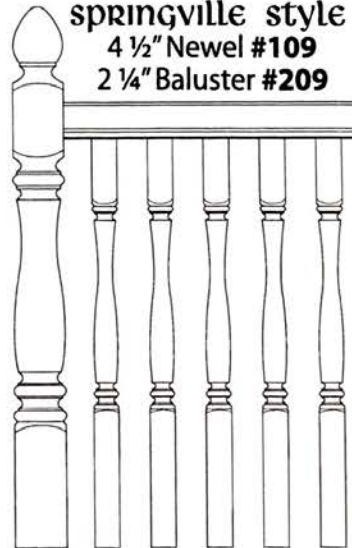

1/16 Scale  
1/16" = 1"

# VICTORIAN style #114

5 1/2"

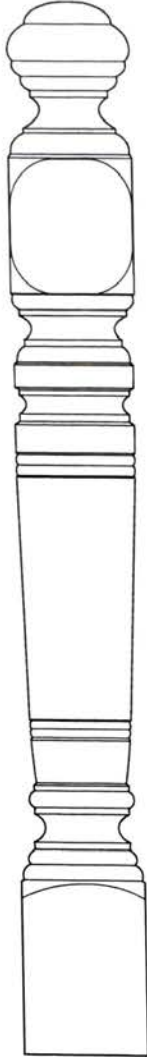

1 3/4"  
Victorian  
#214

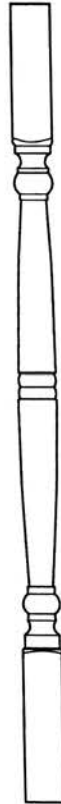

1/8 Scale  
1/8" = 1"

victorian style  
5 1/2" Newel #114  
1 3/4" Baluster #214

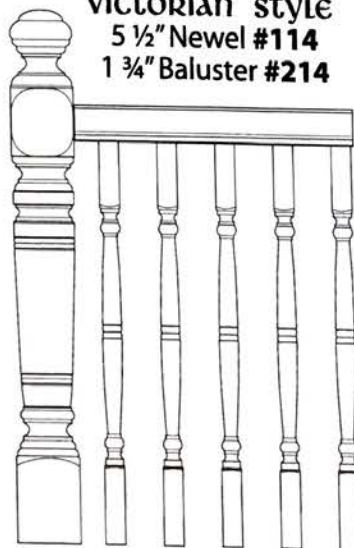

1/16 Scale  
1/16" = 1"



# empire style #116

5"



2 1/4"  
Empire  
#216



1/8 Scale  
1/8" = 1"

empire style  
5" Newel #116  
2 1/4" Baluster #216

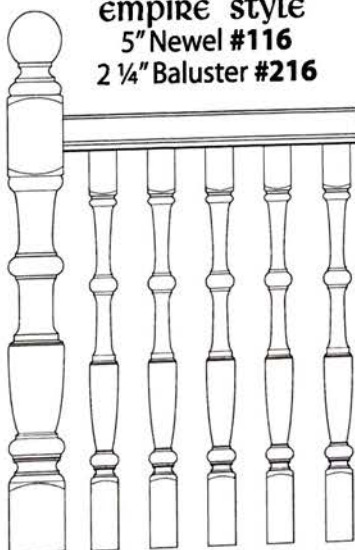

1/16 Scale  
1/16" = 1"

# REGENCY style #110

3 1/2"

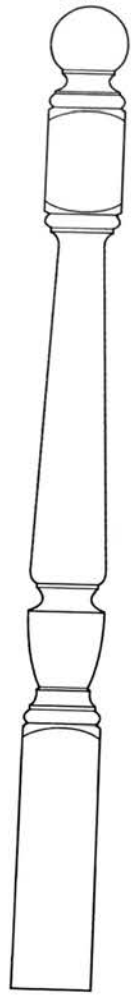

1 3/4"  
Regency  
#210



1/8 Scale  
1/8" = 1"

Regency style  
3 1/2" Newel #C-110  
1 3/4" Baluster #210

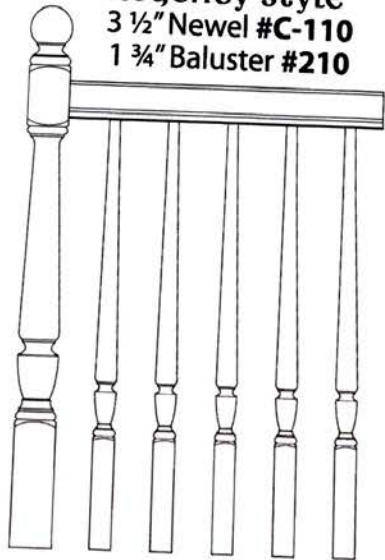

1/16 Scale  
1/16" = 1"

# shaker style #104

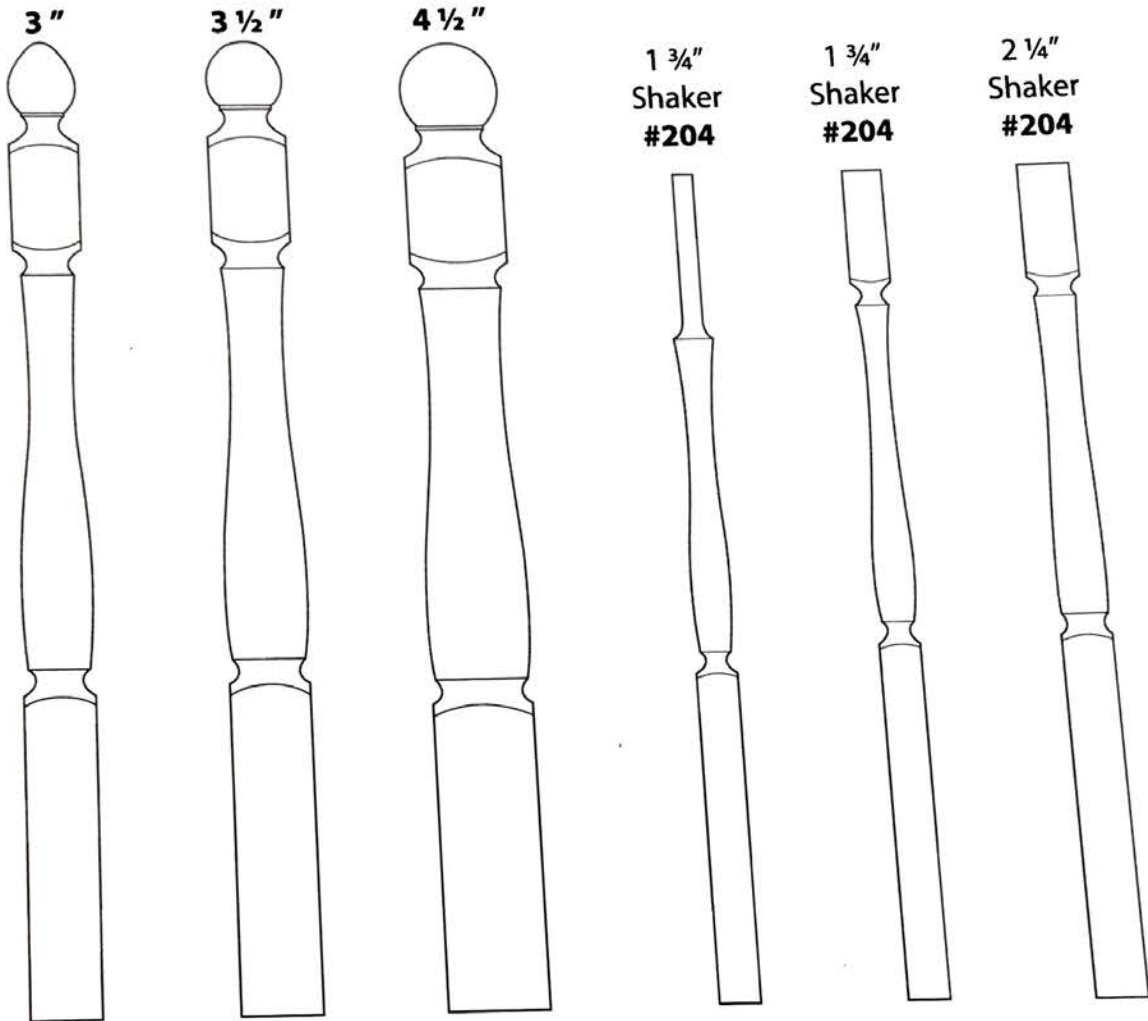

1/8 Scale  
1/8" = 1"

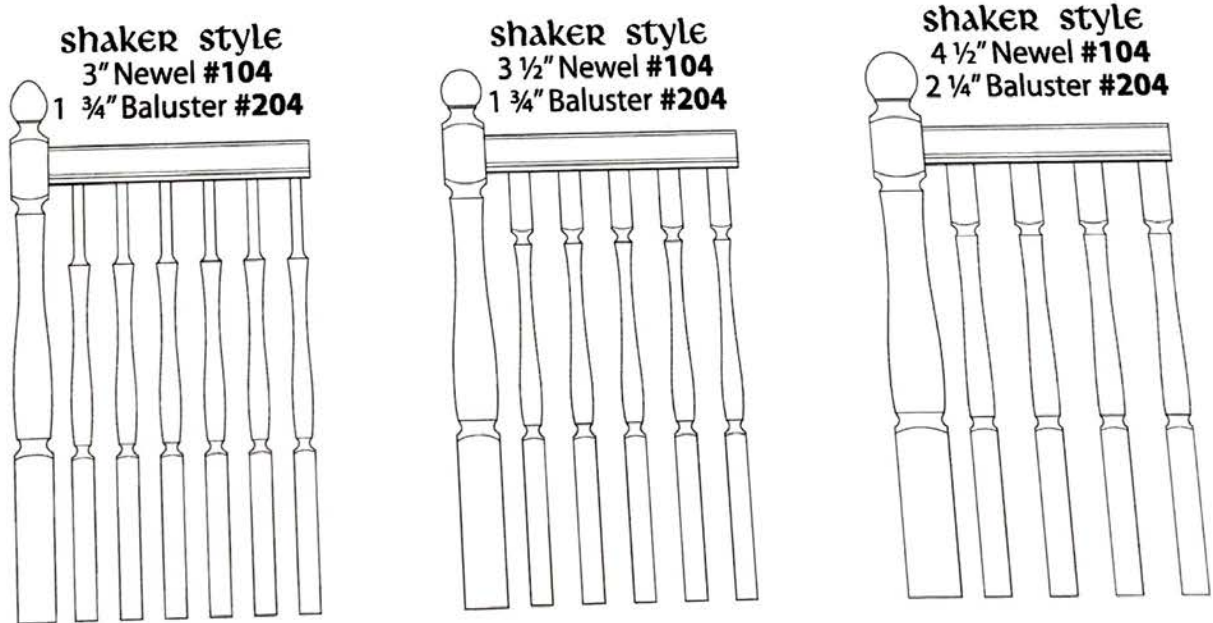

1/16 Scale  
1/16" = 1"

# colonial style #112

**3" A**

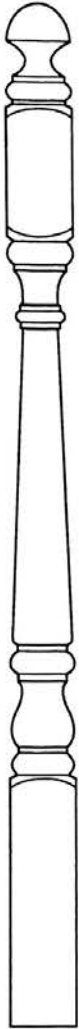

**3" B**



**3 1/2" A**



**3 1/2" B**



**1 3/4" Colonial #212**



1/8 Scale  
1/8" = 1"

colonial style  
**3" A Newel #112**  
**1 3/4" Baluster #212**

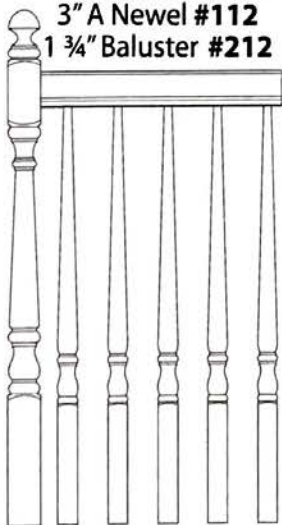

colonial style  
**3" B Newel #112**  
**1 3/4" Baluster #212**

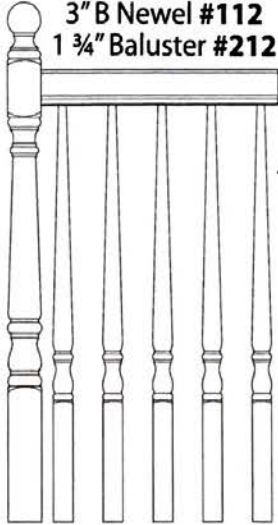

colonial style  
**3 1/2" B Newel #112**  
**1 3/4" Baluster #212**

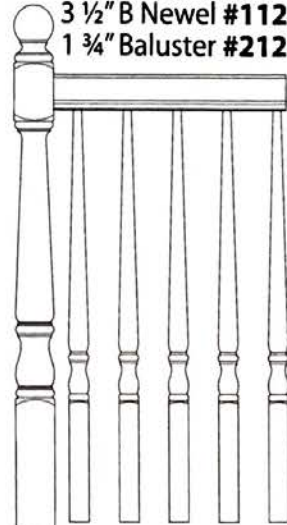

1/16 Scale  
1/16" = 1"

# vineyard style #107

4 1/2"

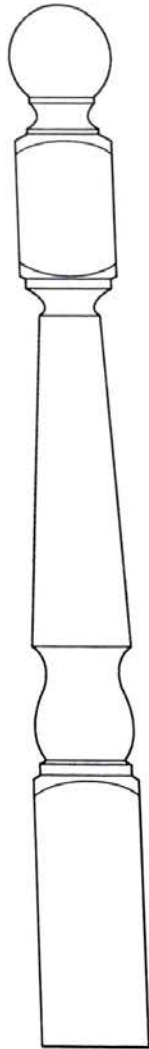

1 3/4"  
Vineyard  
#207



1 3/4"  
Vineyard  
#207

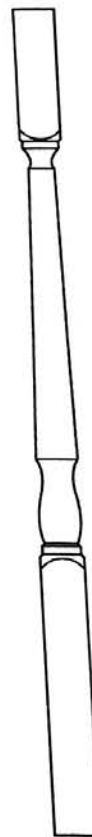

1/8 Scale  
1/8" = 1"

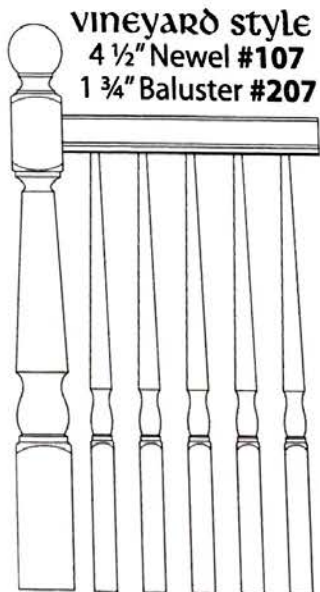

**vineyard style**  
4 1/2" Newel #107  
1 3/4" Baluster #207

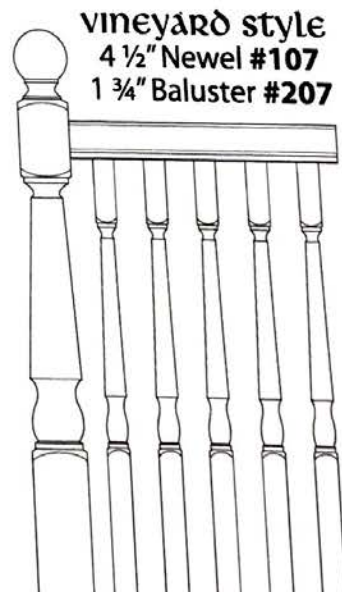

**vineyard style**  
4 1/2" Newel #107  
1 3/4" Baluster #207

1/16 Scale  
1/16" = 1"

# alpine style #106

3 1/2"

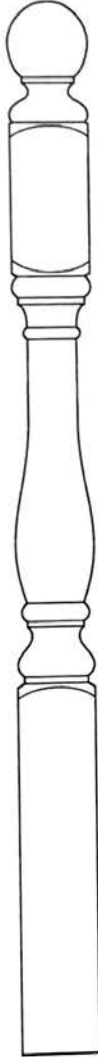

5 1/2"

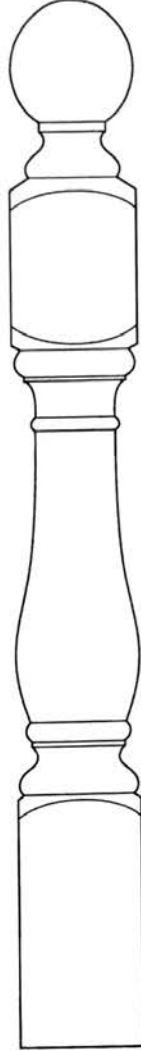

1 3/4"  
Alpine  
#206



2 1/4"  
Alpine  
#206



1/8 Scale  
1/8" = 1"

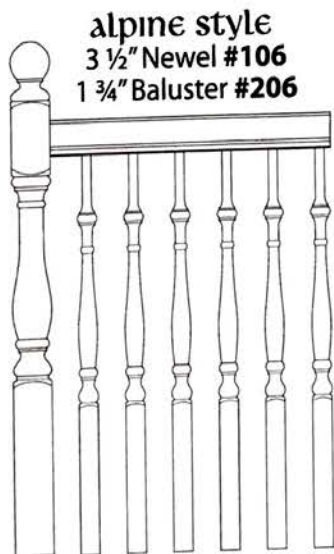

1/16 Scale  
1/16" = 1"



# modern style #113

3 1/2"

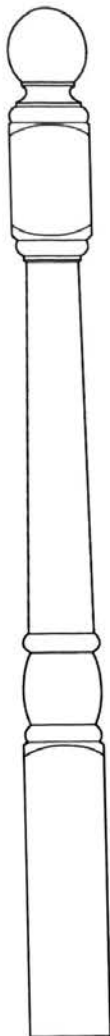

1 3/4"  
Modern  
#213



1/8 Scale  
1/8" = 1"

modern style  
3 1/2" Newel #113  
1 3/4" Baluster #213

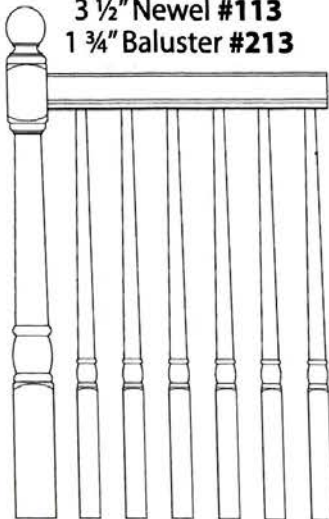

1/16 Scale  
1/16" = 1"

# MEDITERRANEAN style #108

3 1/2"

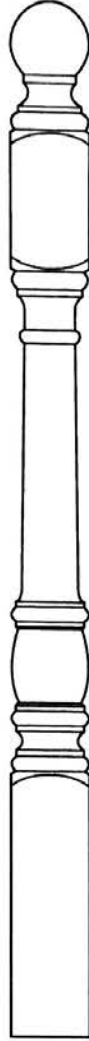

1 3/4"  
Mediterranean  
#208



1/8 Scale  
1/8" = 1"

MEDITERRANEAN style

3 1/2" Newel #108

1 3/4" Baluster #208

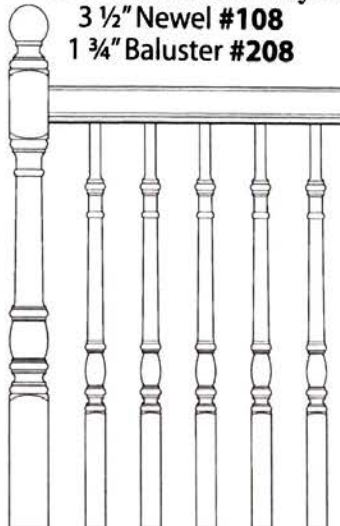

1/16 Scale  
1/16" = 1"



# straight column #115

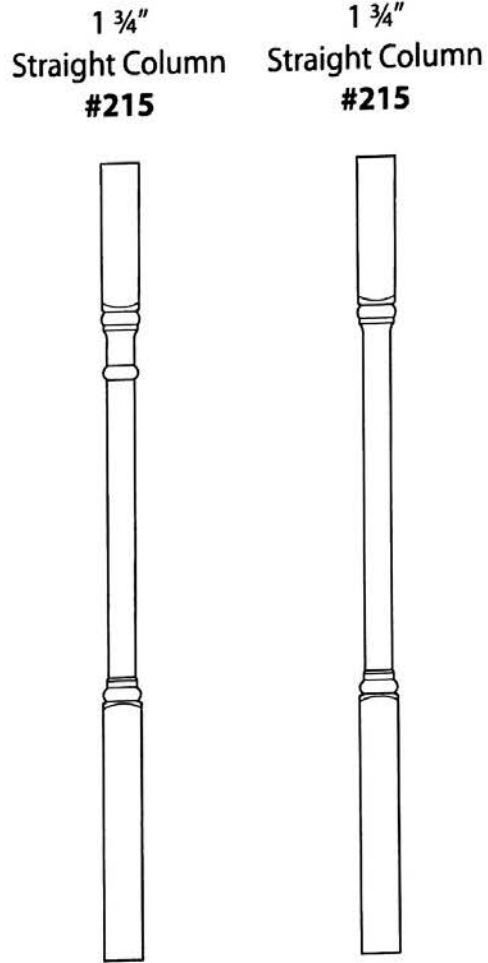
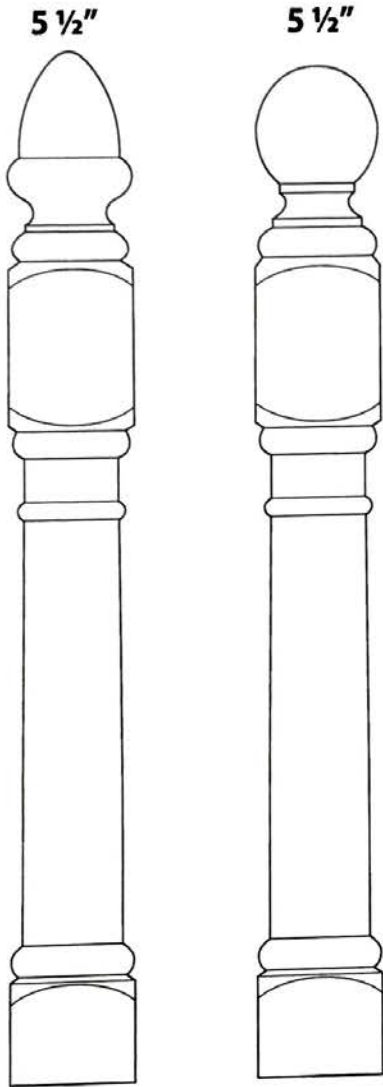

1/8 Scale  
1/8" = 1"

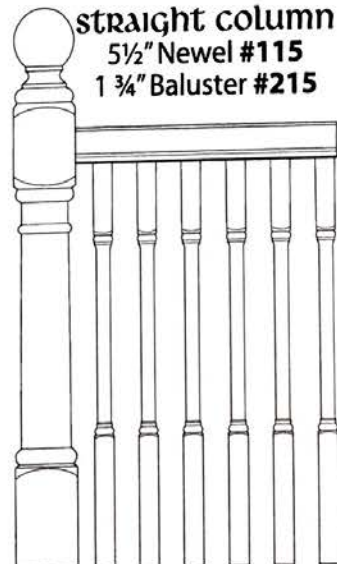
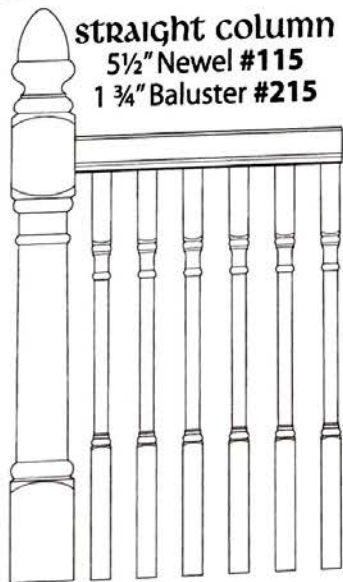

1/16 Scale  
1/16" = 1"

Large Breadloaf  
#6210



small Breadloaf  
#6010



IVES MODERN  
#104



IVES  
traditional  
#101

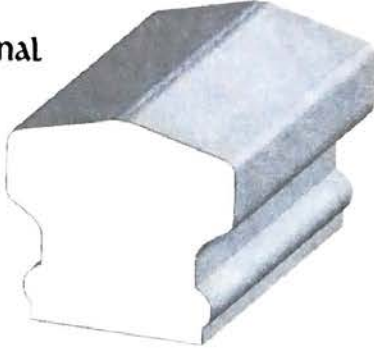

commercial  
traditional  
#101-C

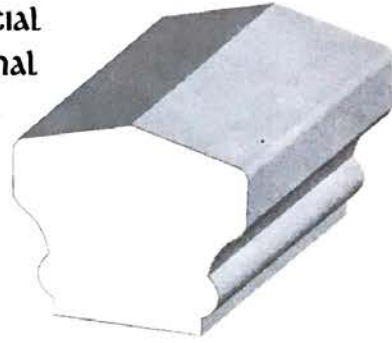

IVES classic  
#102



IVES vintage  
#103



IVES craftsman  
#1010

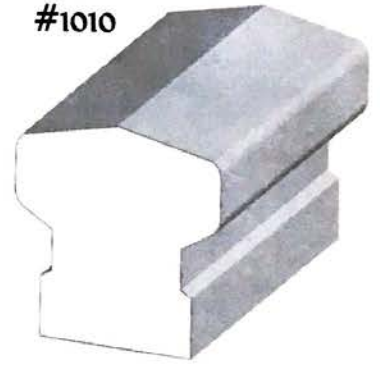

IVES classic style  
special #1  
#102-s



IVES classic style  
special #2  
#102-s

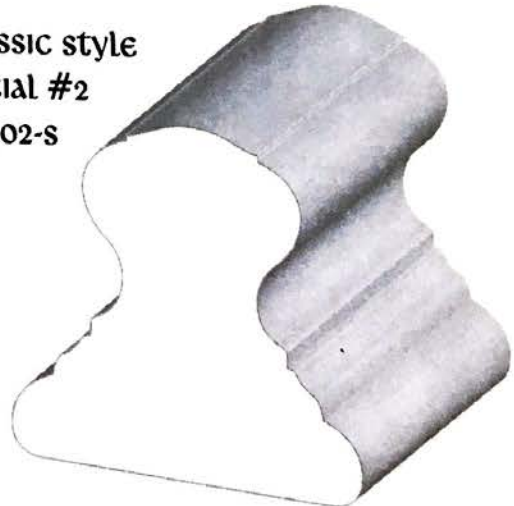

1/2 Scale  
1/2" = 1"

#1

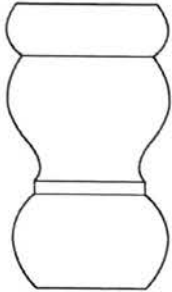
3 1/2" Diameter  
6" Tall

#2

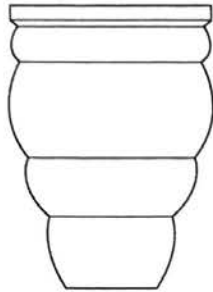
4 1/2" Diameter  
6" Tall

#3

5" Diameter  
6" Tall

#4-1

4 3/4" Diameter  
5 1/4" Tall  
3 1/8"

#4-2

4" Diameter  
4" Tall

#5

4" Diameter  
4" Tall

#6

4" Diameter  
4" Tall

#7-1

4 1/2" Diameter  
6" Tall

#7-2

4" Diameter  
4" Tall

#7-3

4 1/2" Diameter  
4" Tall

#7-4

4 1/2" Diameter  
5 1/4" Tall

#8

4" Diameter  
2" Tall

#9

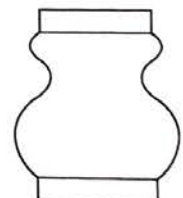
3 1/2" Diameter  
4" Tall

#10-1

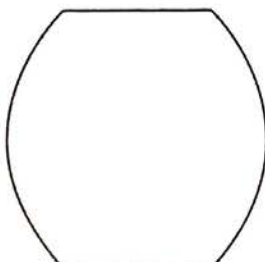
5 1/2" Diameter  
5 1/4" Tall

#10-2

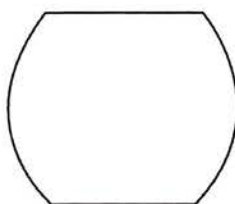
4 1/2, 5, 6" Diameter  
4" Tall

#11

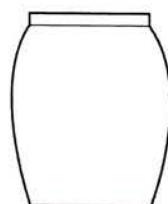
3, 3 1/2, 4" Diameter  
4" Tall

#12

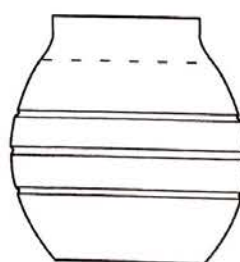
5" Diameter  
4 or 5" Tall

#13

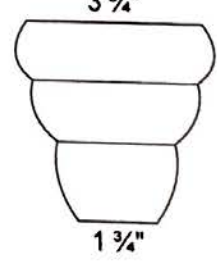
4 1/4" Diameter  
4" Tall  
3 3/4"1/4 Scale  
1/4" = 1"

**#14**  
4" Diameter  
4" Tall

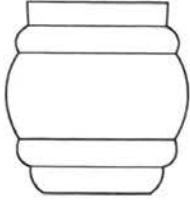

**#15**  
3 1/2" Diameter  
4 1/2" Tall



**#16**  
3 1/2" Diameter  
4" Tall



**#17**  
3 1/2" Diameter  
3 1/4" Tall  
2 5/8"

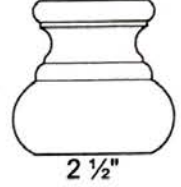

**#18**  
4" Diameter  
4" Tall



**#19-1**  
3 1/2" Diameter  
4" Tall



**#19-2**  
5 1/2" Diameter  
4" Tall

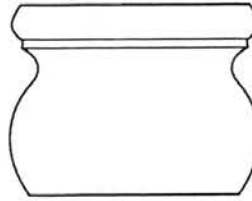

**#20**  
4" Diameter  
5 3/4" Tall



**#21**  
5" Diameter  
3" Tall

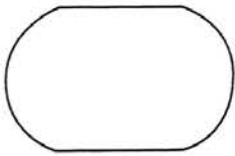

**#22**  
4" Diameter  
4" Tall  
2 5/8"

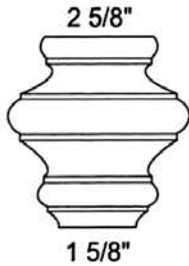

**#23**  
4" Diameter  
4" Tall  
2 5/8"

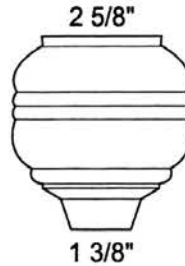

**#24**  
5 1/2" Diameter  
4 1/2, 5, 6" Tall

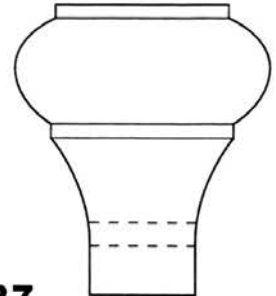

**#25**  
4" Diameter  
6" Tall



**#26**  
3 1/2" Diameter  
4, 4 1/2" Tall



**#27**  
4" Diameter  
4, 5" Tall



1/4 Scale  
1/4" = 1"

**#28**  
5" Diameter  
5" Tall

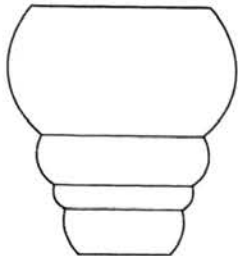

**#29**  
6" Diameter  
6" Tall

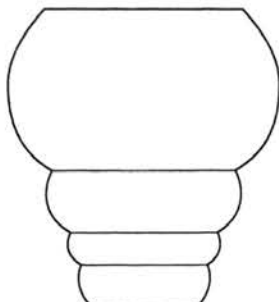

**#30**  
4" Diameter  
4" Tall



**#31**  
4½" Diameter  
6" Tall



**#32**  
4" Diameter  
4" Tall



**#33**  
4" Diameter  
4" Tall



To Match Leg# 364

**#34**  
4" Diameter  
4 ½" Tall



**#35**  
5" Diameter  
4½" Tall



**#36**  
5" Diameter  
4" Tall



1/4 Scale  
1/4" = 1"

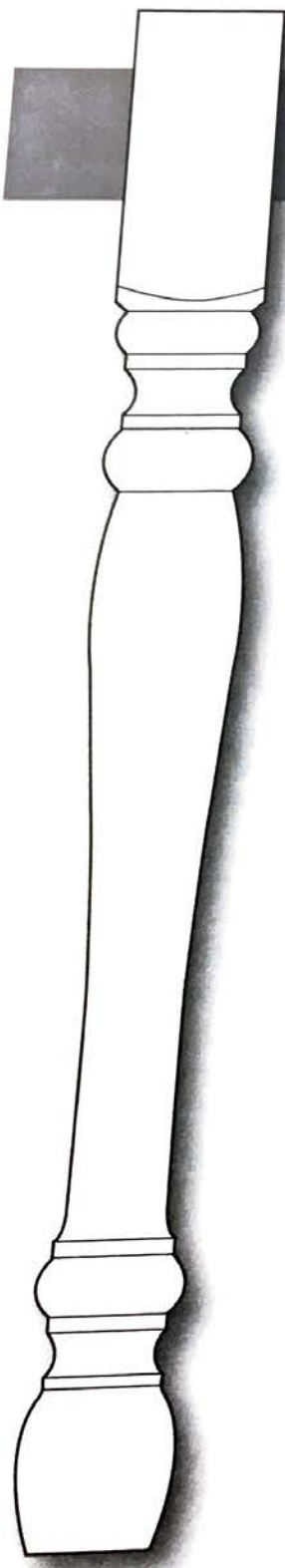

# Furniture & Table Legs

All Furniture and Table Legs are available in a variety of lengths and sizes. If a size is not present in the illustrations, call Ives Woodturning, Inc. for availability.

Ives Woodturning, Inc. specializes in custom woodturnings, so we can match your drawings, pictures, or examples.

All Furniture and Table Legs can be fluted upon request for an additional charge.

All Furniture and Table Legs are priced according to size and wood selection.

Patterns are available in any block size upon request.

**We Now Offer  
Spiral Turnings  
On Selected Styles  
Call For Availability**

## table legs

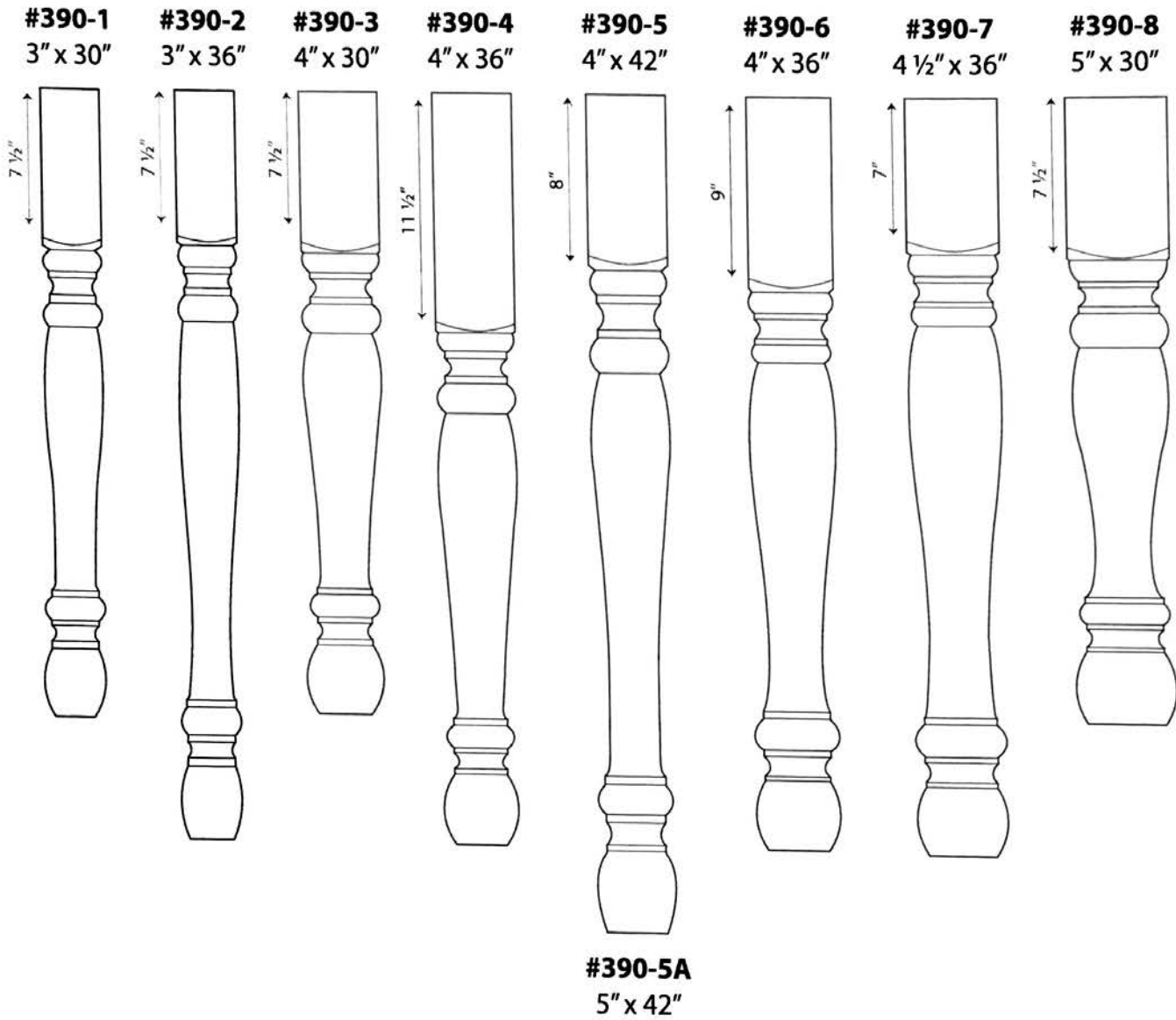

Patterns are available in any block size upon request.

1/8 Scale  
1/8" = 1"

# table legs

**#390-9**  
3 1/2 or 4" x 36"



**#390-10**  
5 1/2" x 36"



**#390-11**  
5 1/2" x 42"

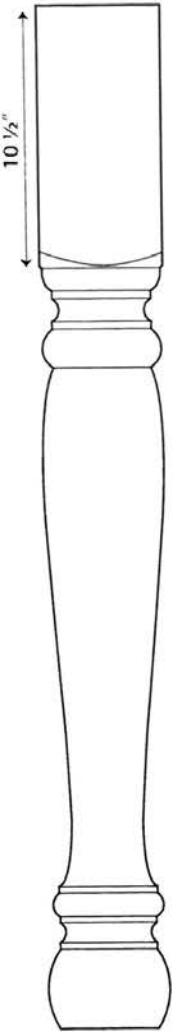

**#390-12**  
3" x 36"



**#300-1**  
3" x 36"



**#300-2**  
3 1/2" x 42"

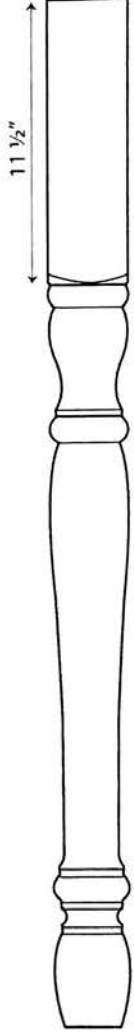

**#300-3**  
3" x 42"



**#300-4**  
3 1/2" x 30"



Patterns are available in any block size upon request.

1/8 Scale  
1/8" = 1"



## table legs

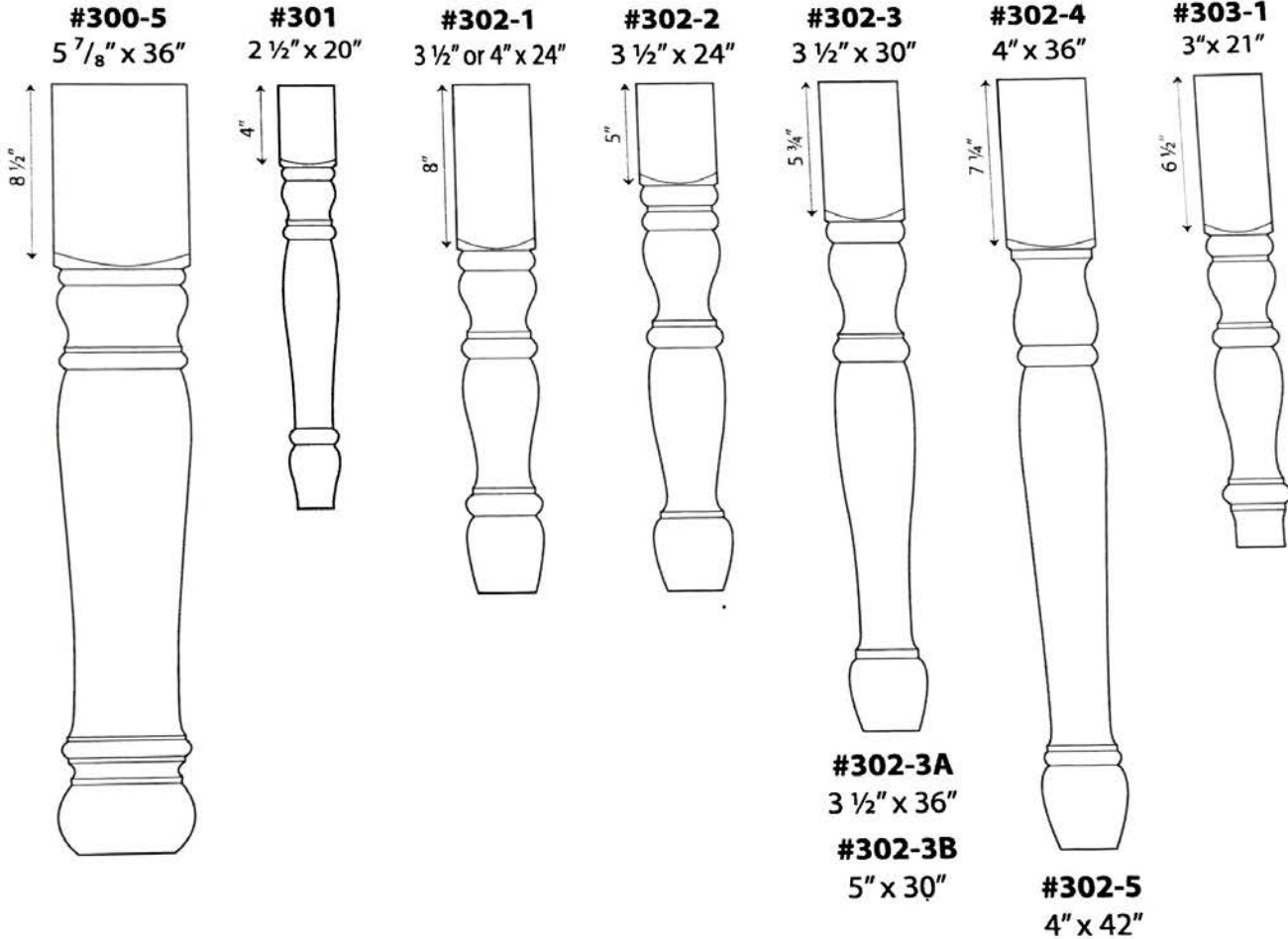

Patterns are available in any block size upon request.

1/8 Scale  
1/8" = 1"

# table legs

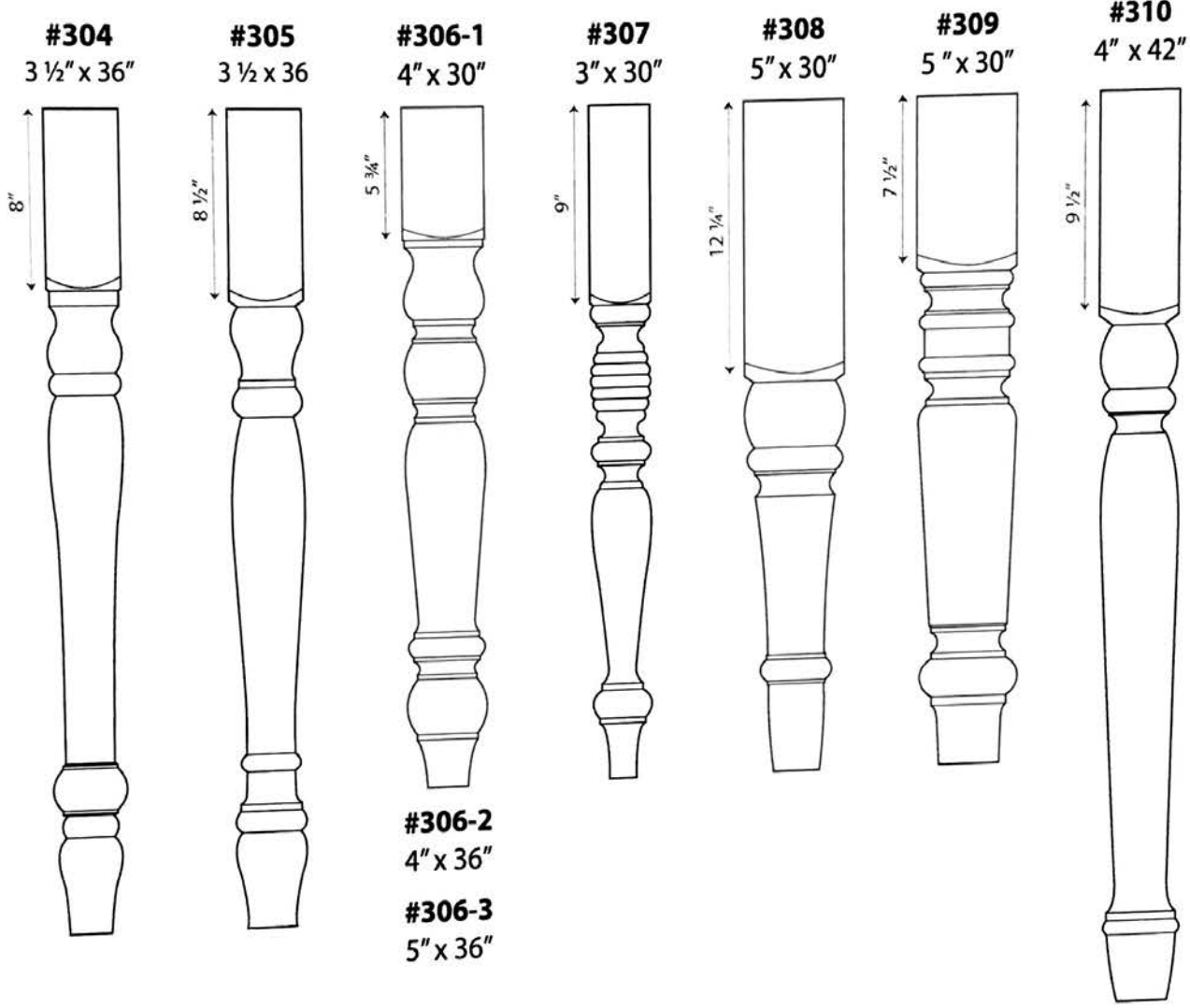

Patterns are available in any block size upon request.

1/8 Scale  
1/8" = 1"

# table legs

**#311-1**  
3" x 30"



**#311-2**  
3" x 36"

**#312**  
3" x 30"



**#313-1**  
3 1/2" x 36"



**#314-1**  
3 1/2" x 30"



**#314-2**  
3 1/2" x 36"



**#314-2**  
4" x 36"



**#314-3**  
3 1/2" x 42"

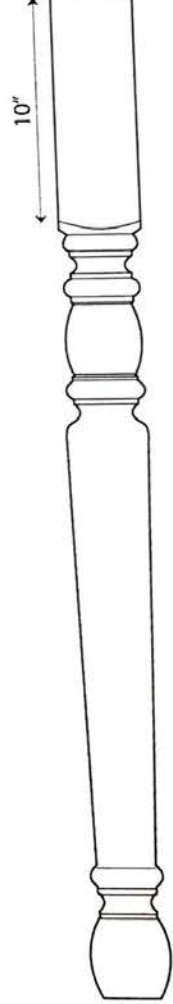

Patterns are available in any block size upon request.

1/8 Scale  
1/8" = 1"

# table legs

**#315-1**  
5" x 36"

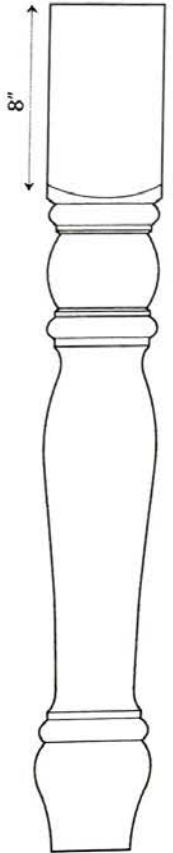

**#315-2**  
5" x 42"

**#316**  
3" x 30"



**#317-1**  
3" x 15"



**#318**  
5" x 36"



**#320**  
4" x 30"

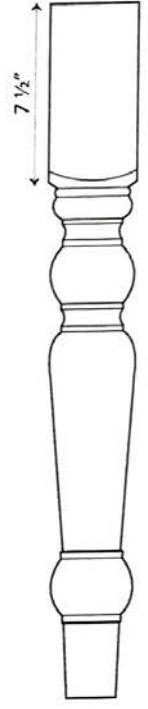

Patterns are available in any block size upon request.

1/8 Scale  
1/8" = 1"

## table legs

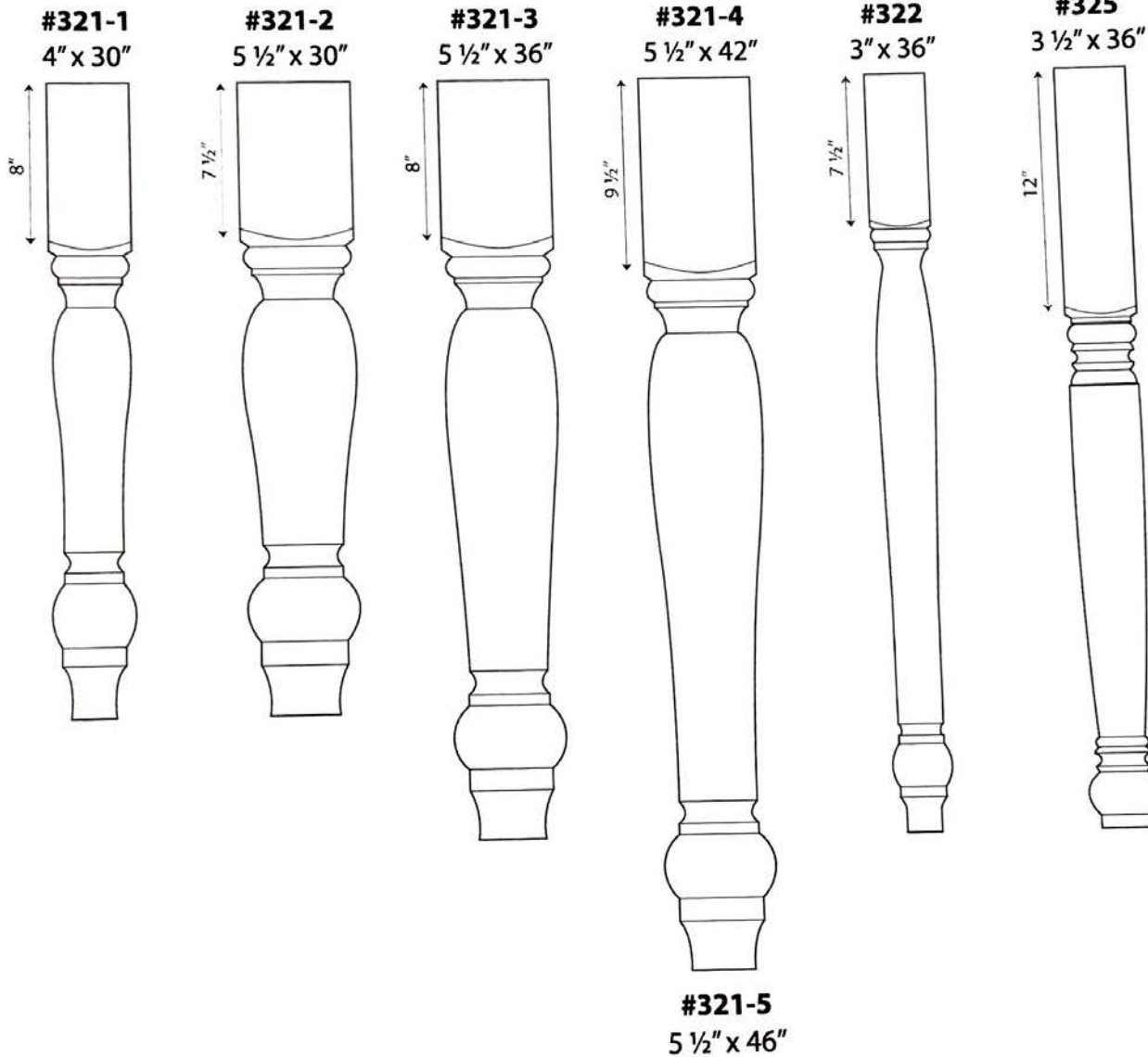

Patterns are available in any block size upon request.

1/8 Scale  
 1/8" = 1"

# table legs

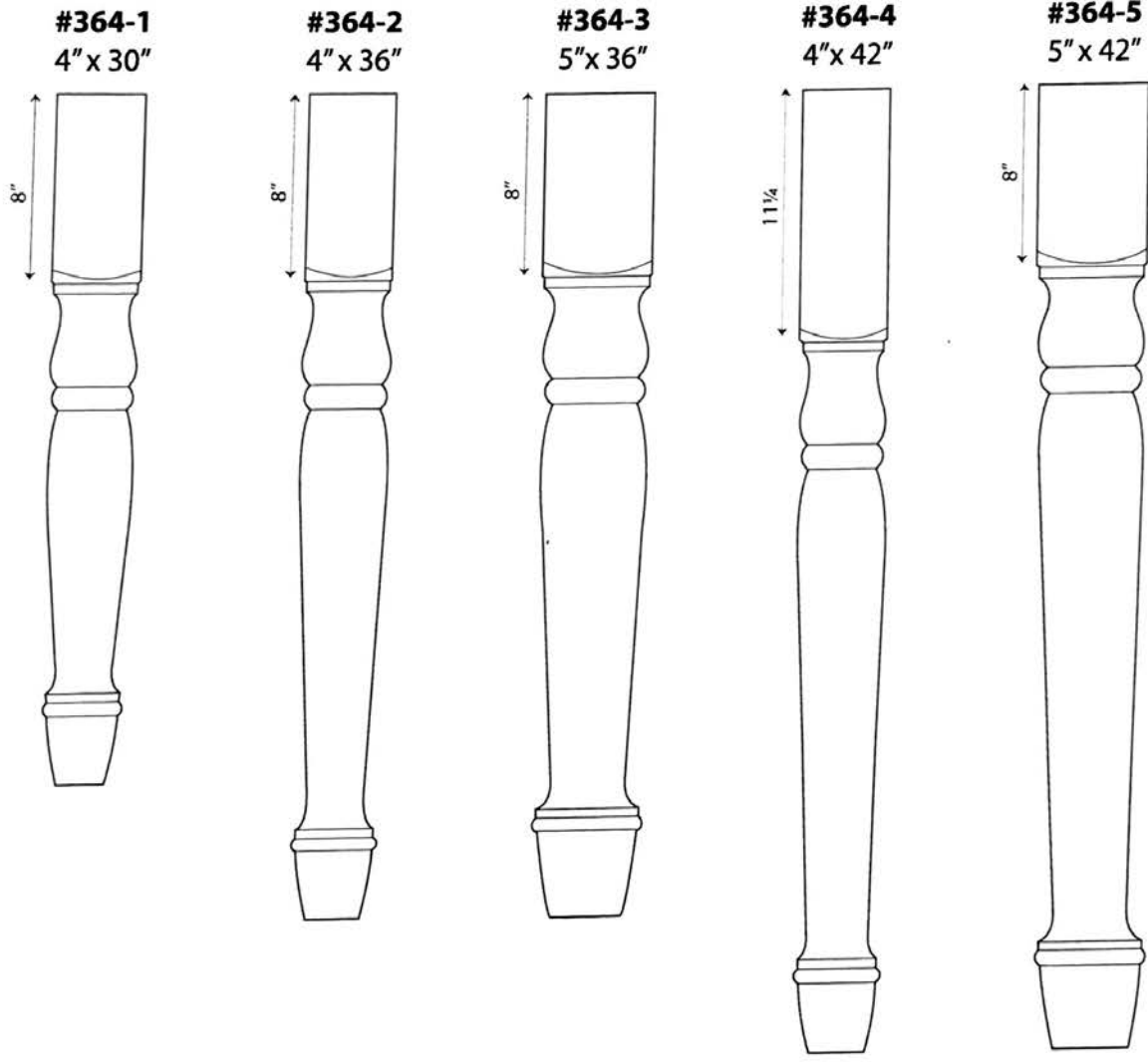

Patterns are available in any block size upon request.

1/8 Scale  
1/8" = 1"

# furniture legs

**#400-1**  
3 1/2" x 36"

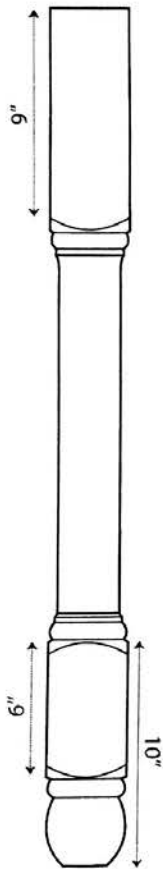

**#400-2**  
3 1/2" x 42"

**#401-1**  
3" or 3 1/2" x 36"

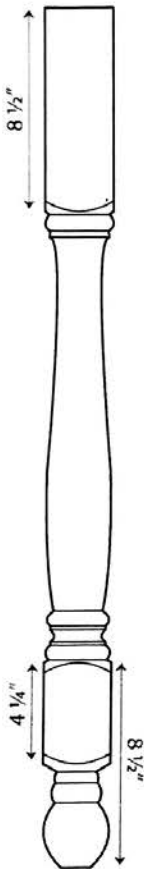

**#402**  
3" or 3 1/2" x 36"

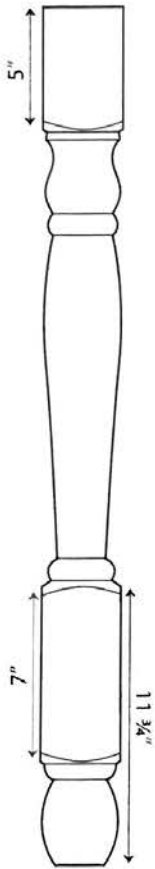

**#403**  
3" x 36"

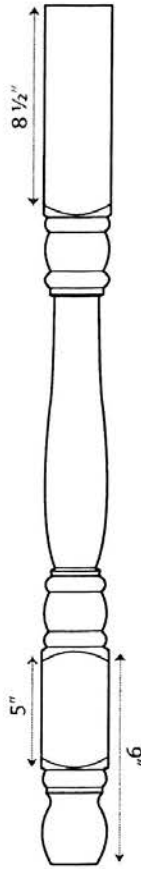

**#404**  
3 1/2" x 36"

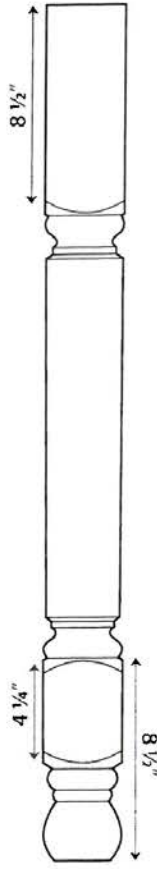

**#405-1**  
4" x 36"

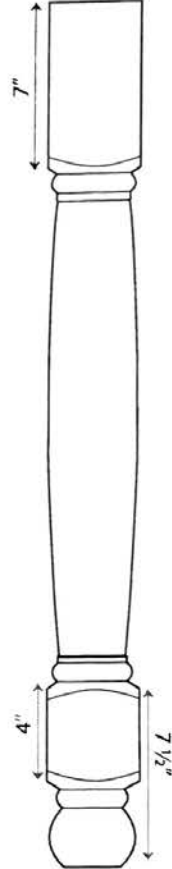

**#405-2**  
4" x 42"

Patterns are available in any block size upon request.

1/8 Scale  
1/8" = 1"

# furniture legs

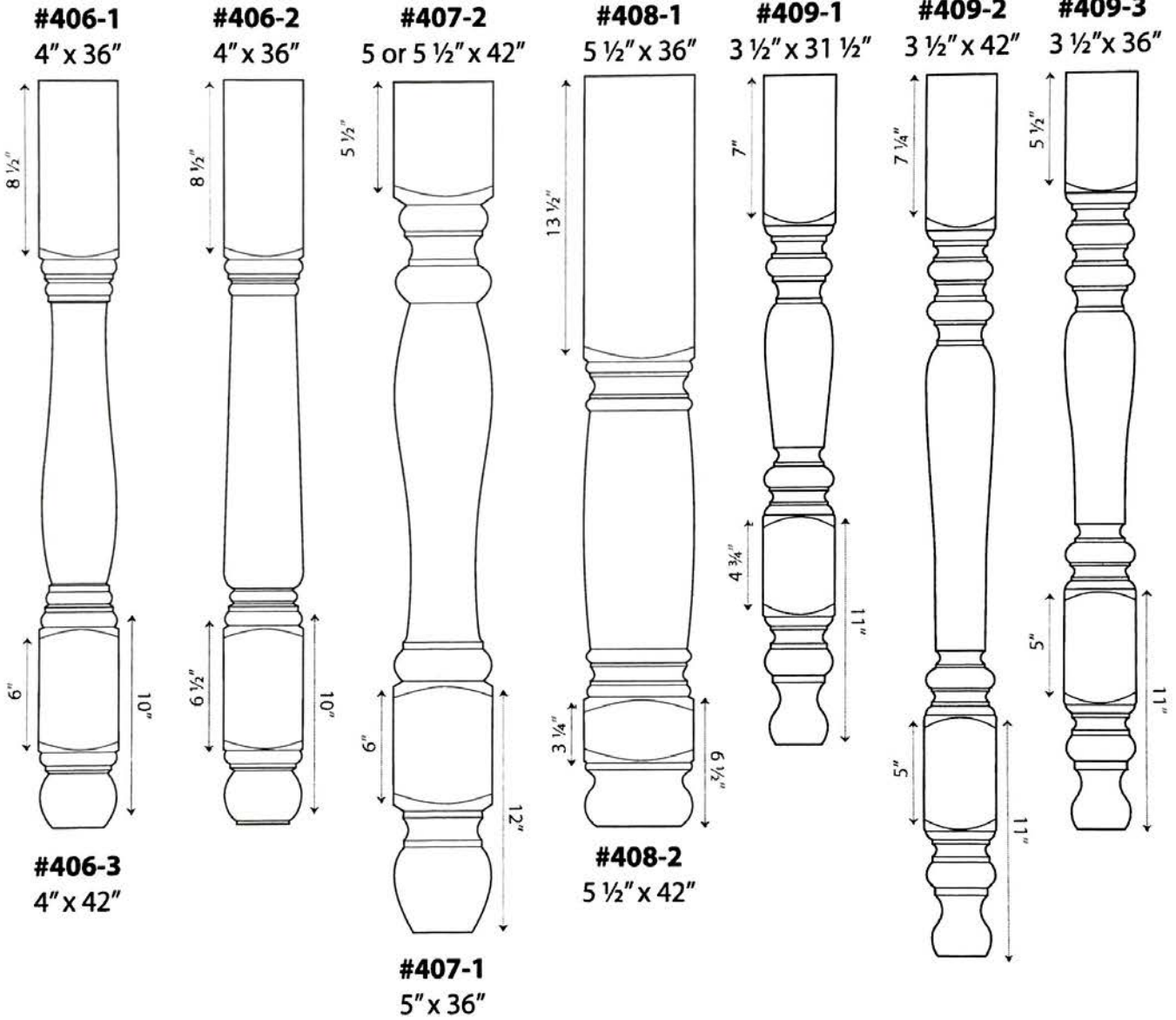

Patterns are available in any block size upon request.

1/8 Scale  
1/8" = 1"



# furniture legs

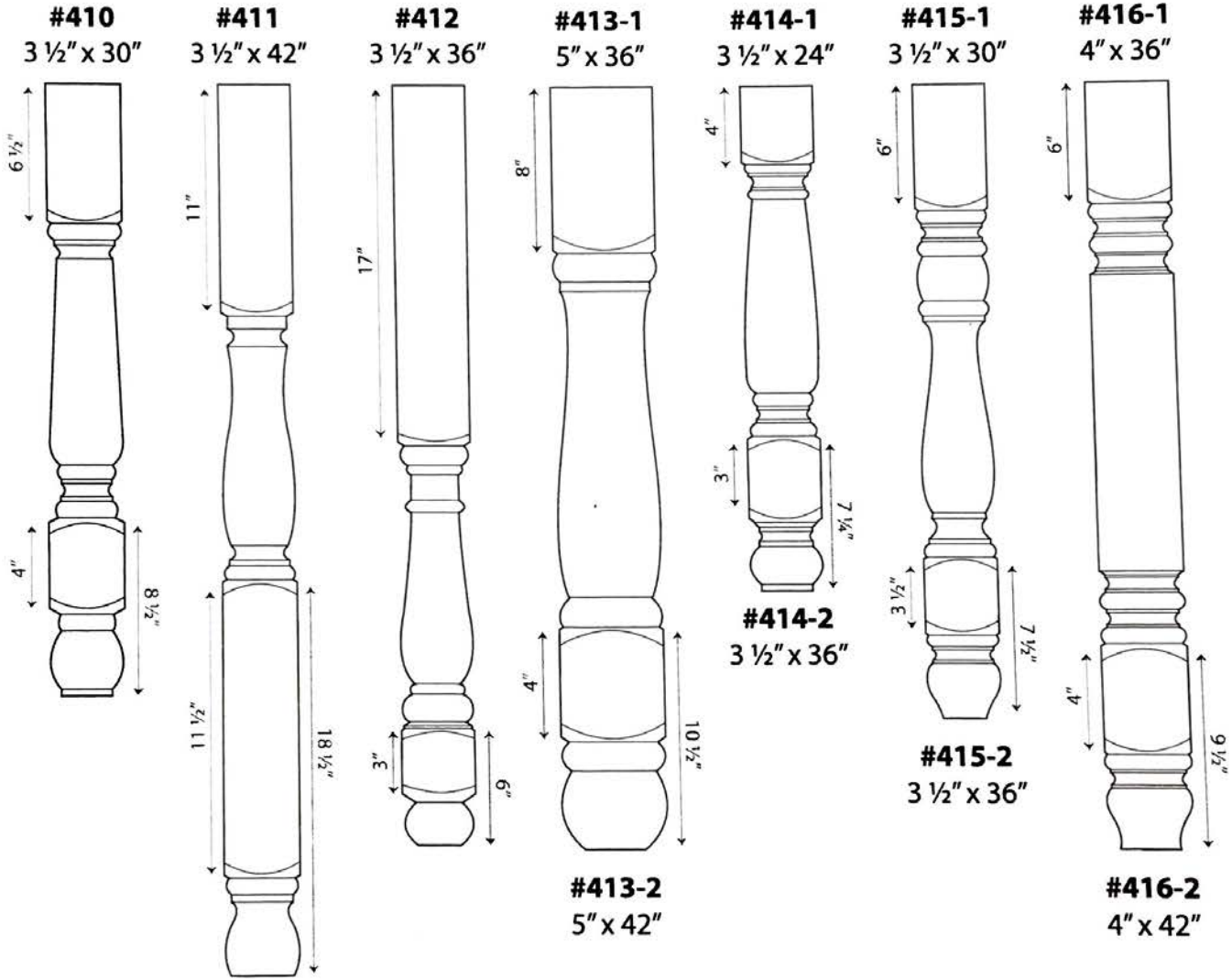

Patterns are available in any block size upon request.

1/8 Scale  
1/8" = 1"

# furniture legs

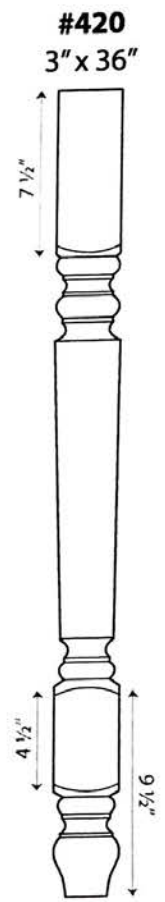
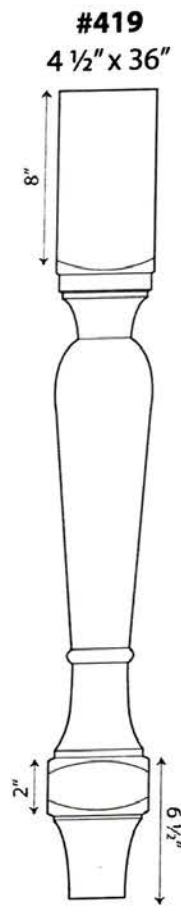
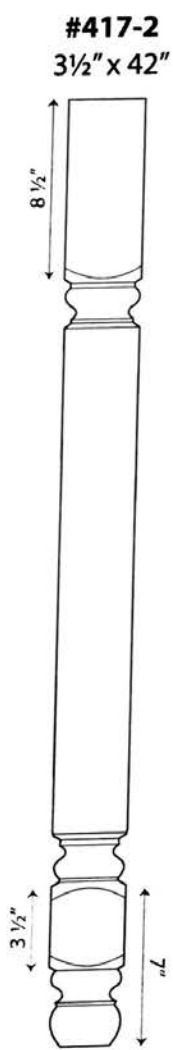
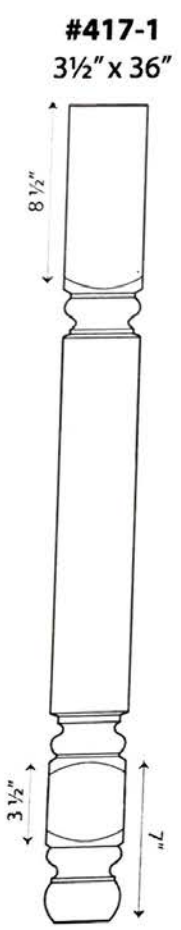

Patterns are available in any block size upon request.

1/8 Scale  
1/8" = 1"

## turned posts

**#500-1**  
4-5 1/2" x 36"

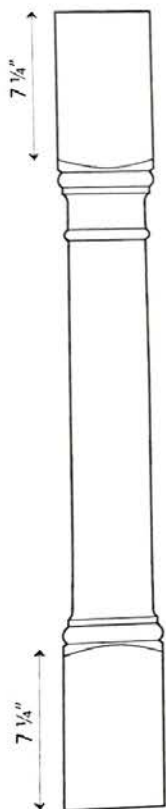

**#500-2**  
4" x 42"

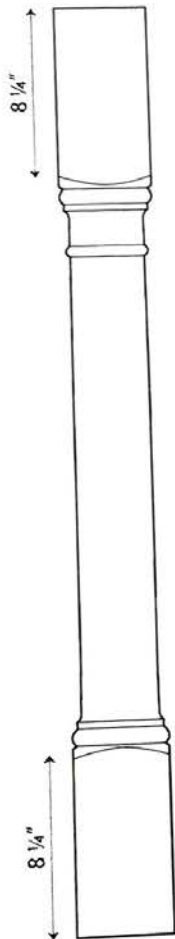

**#501-1**  
3 1/2- 5 1/2" x 36"

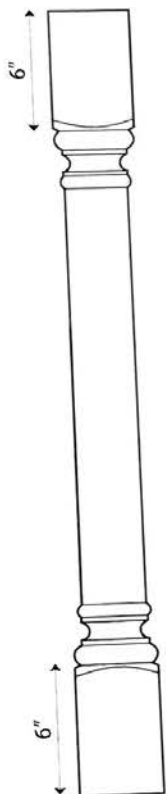

**#501-2**  
3-5 1/2" x 36"

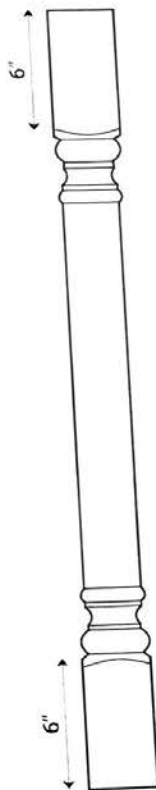

**#501-3**  
3-5 1/2" x 30"

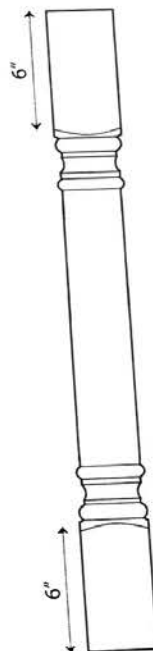

**#503**  
3" x 36"

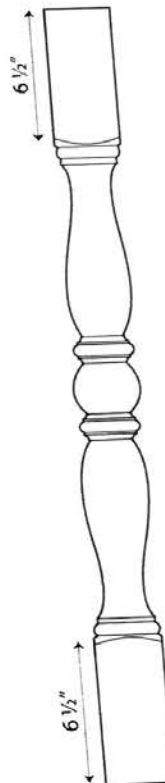

**#501-4**  
3 1/2" x 30"

**#501-5**  
4" x 36"

**#501-6**  
4" x 42"

**#501-7**  
5" x 36"

Patterns are available in any block size upon request.

1/8 Scale  
1/8" = 1"

# turned posts

**#504-1**  
3" x 36"

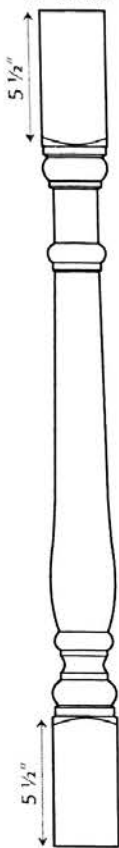

**#504-2**  
3 1/2" x 24"

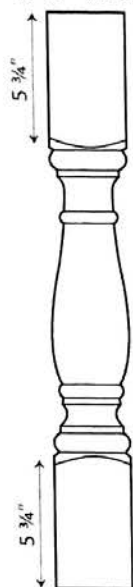

**#504-3**  
2 1/2" x 26"



**#504-4**  
3" x 30"



**#504-5**  
3 1/2" x 36"



**#505-1**  
5" x 36"



**#505-2**  
4" x 36"



**#505-3**  
5 1/2" x 36"







- #504-7**  
3" x 36"
- #504-8**  
3" x 39"
- #504-9**  
3" x 42"

**#504-6**  
5" x 42"

Patterns are available in any block size upon request.

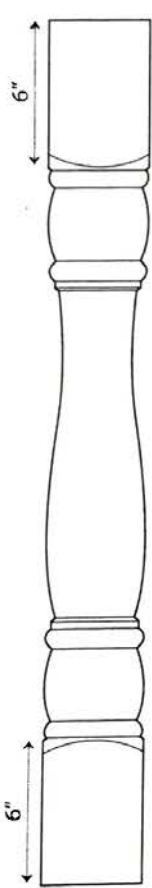
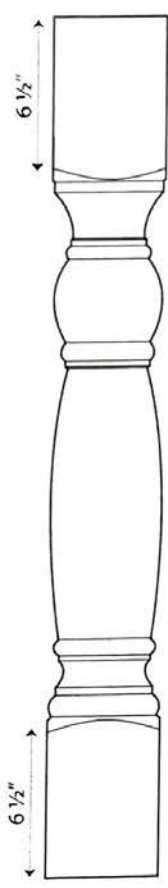
1/8 Scale  
1/8" = 1"

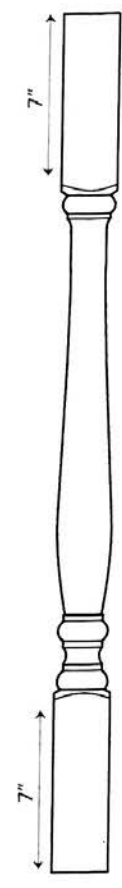
# turned posts

<b>#506-1</b> 3 1/2" x 36"	<b>#506-2</b> 4 1/2" x 36"	<b>#507-1</b> 5" x 36"	<b>#508-1</b> 3 1/2" x 36"	<b>#510-1</b> 2 1/2" x 36"	<b>#510-2</b> 3 1/2" x 36"	<b>#511-1</b> 3 1/2 - 5" x 36"
						
	<b>#506-3</b> 4 1/2" x 42"	<b>#507-2</b> 5" x 30"				<b>#511-2</b> 3" x 36"
		<b>#507-3</b> 3" x 30"				<b>#511-3</b> 3 1/2 - 5" x 26"
		<b>#507-2</b> 3" x 36"				<b>#511-4</b> 3 1/2 - 5" x 30"
		<b>#507-2</b> 5" x 42"				<b>#511-5</b> 3 1/2 - 5" x 42"

Patterns are available in any block size upon request.

1/8 Scale  
1/8" = 1"

# turned posts

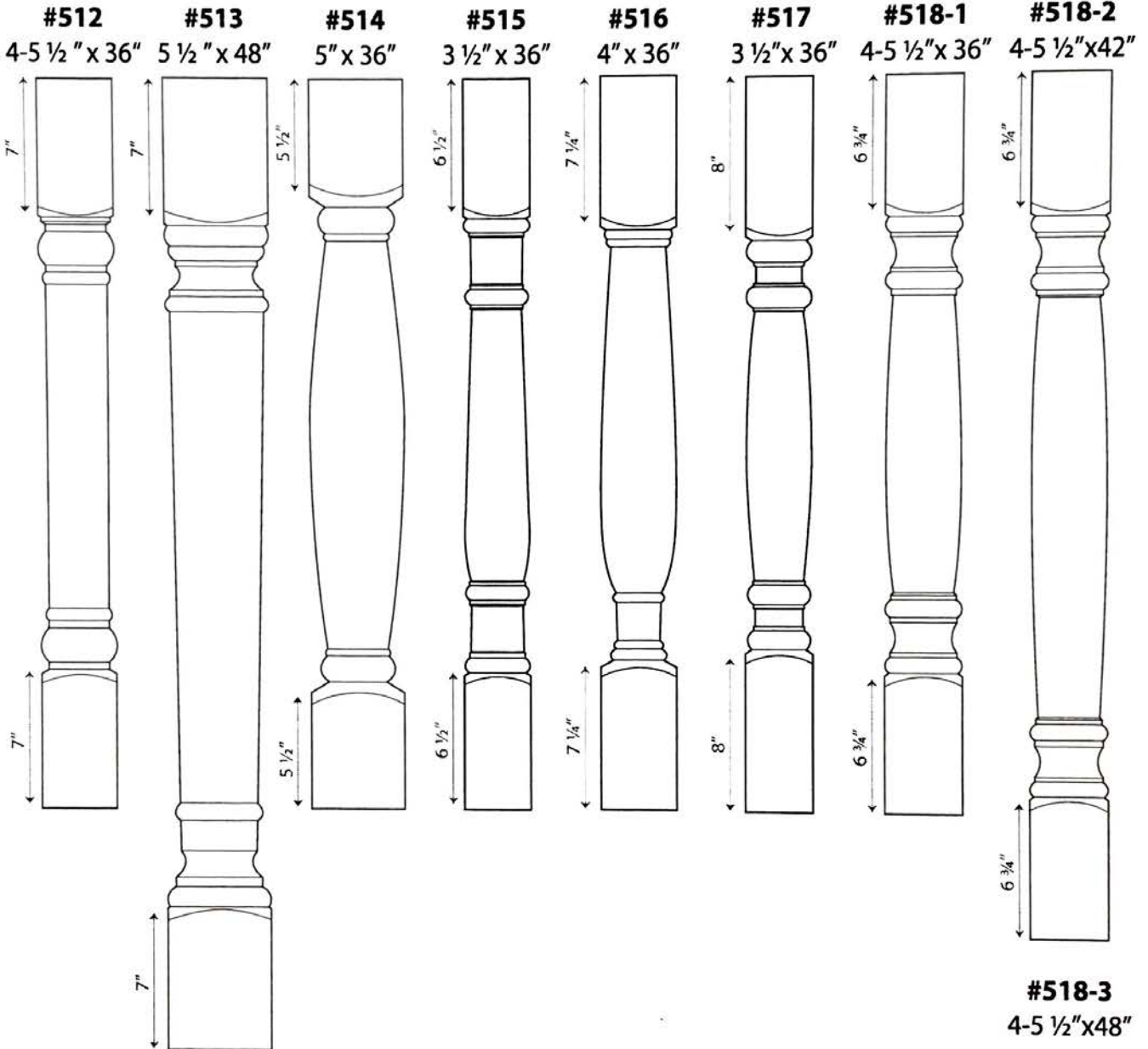

Patterns are available in any block size upon request.

1/8 Scale  
1/8" = 1"

## turned posts

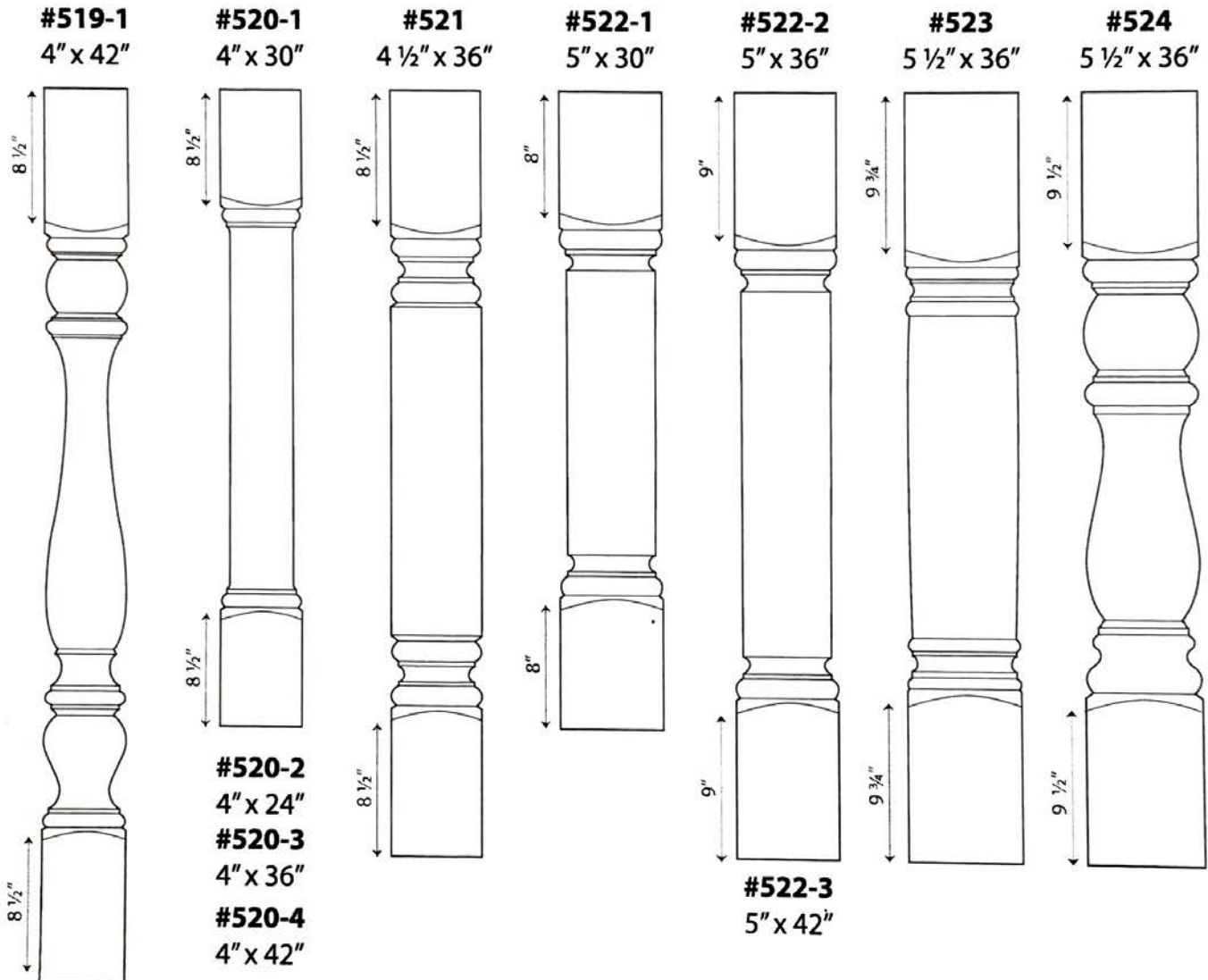

Patterns are available in any block size upon request.

1/8 Scale  
1/8" = 1"

# turned posts

**#539-1**  
3" x 36"



**#539-2**  
3" x 42"

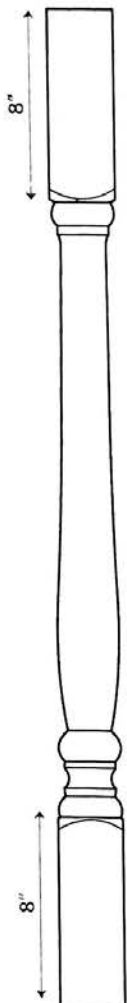

**#539-3**  
3 1/2" x 36"



**#539-4**  
3 1/2" x 42"

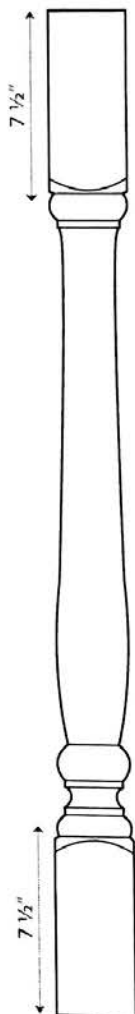

**#539-5**  
4" x 36"



**#539-6**  
4" x 42"



Patterns are available in any block size upon request.

1/8 Scale  
1/8" = 1"



# fireplace columns

**#600**  
1 3/4" x 36"  
Corner Protector



7 1/2"

7 1/2"

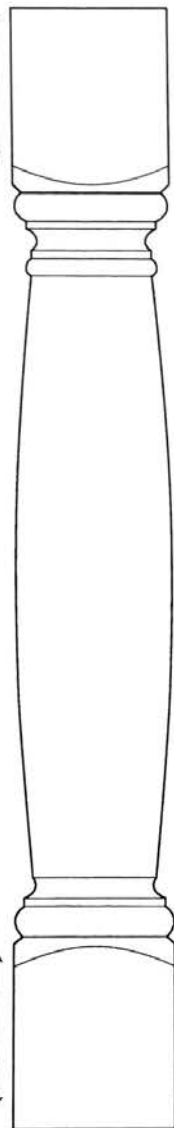

**#700**  
7" x 48"

**#701**  
5 3/4" x 37"

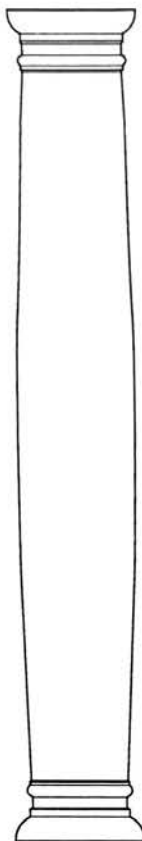

**#702**  
8" x 34"

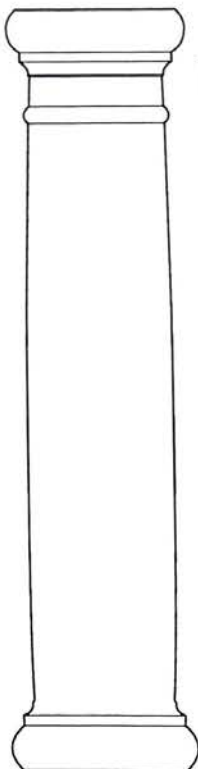

**#703**  
5" x 42"

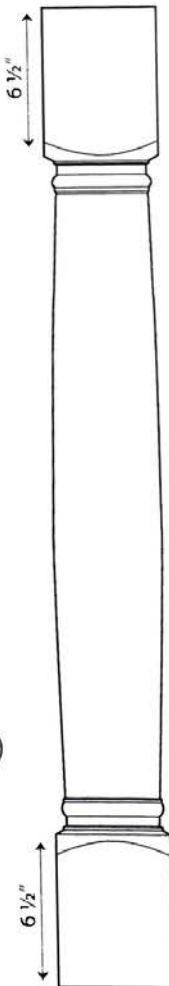

6 1/2"

6 1/2"

**#704**  
6" x 36 1/2"

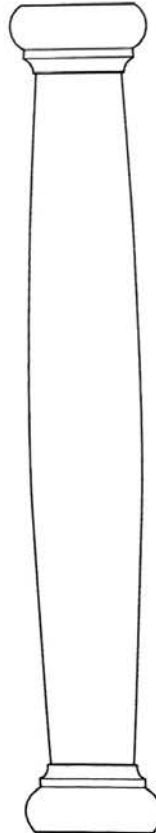

**#705**  
10" x 35"

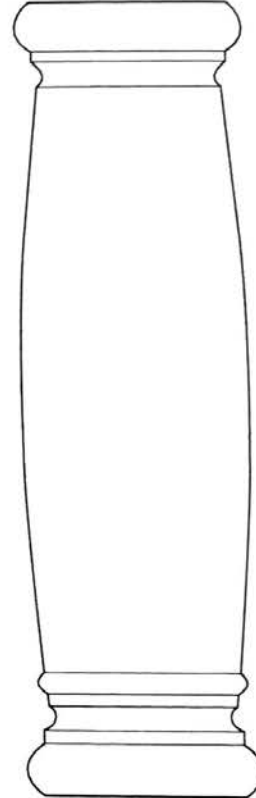

1/8 Scale  
1/8" = 1"

# fluted

**#400-1**  
3 1/2" x 36"

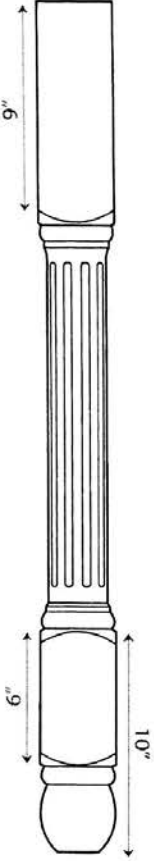

**#500-1**  
4-5 1/2" x 36"

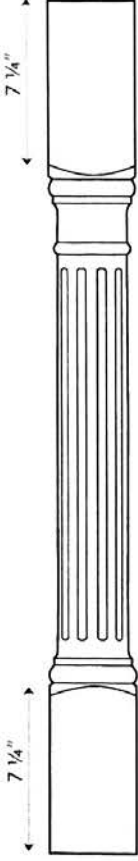

**#501-1**  
3 1/2-5 1/2" x 36"

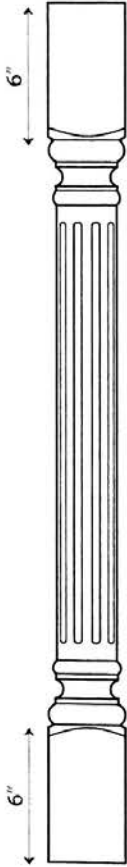

**#501-2**  
3-5 1/2" x 36"



**#501-3**  
3-5 1/2" x 30"



**#512**  
4-5 1/2" x 36"

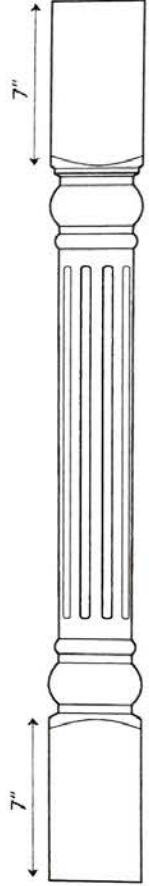

All Newel Posts, Balusters & Turned Posts can be fluted upon request for an additional charge.

1/8 Scale  
1/8" = 1"

## spiral turnings



**Barley Spiral**

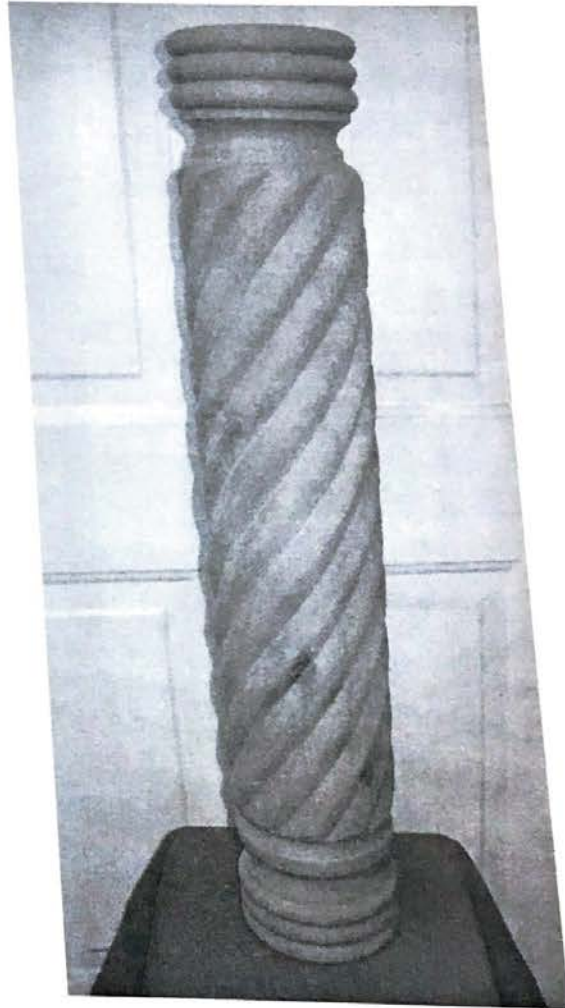

**Rope Spiral**

**Spiral cuts may be added to selected patterns, call for availability.**



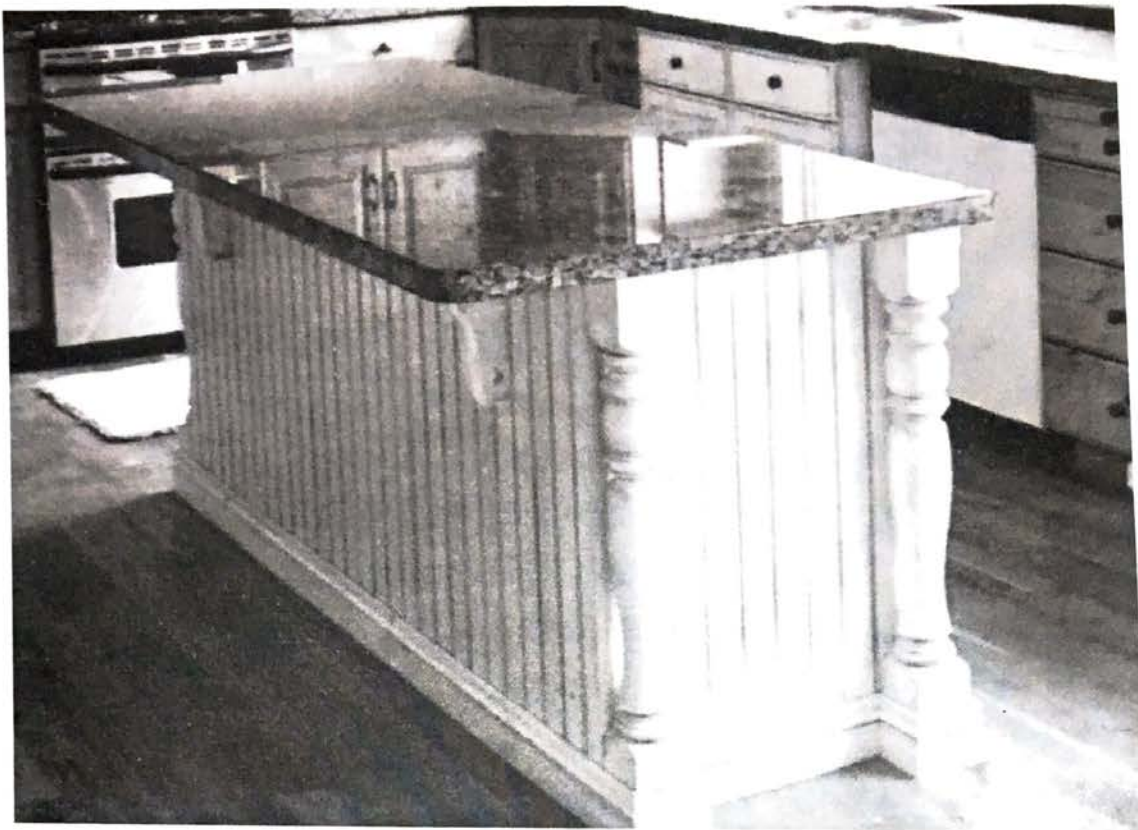

This catalog, including pattern illustrations  
were created by

*Ives Design Studio.*

Contact: Rebecca Ives  
Email: [rebeccaives@comcast.net](mailto:rebeccaives@comcast.net)



IVES WOODTURNING catalog  
3rd Edition, Printed 12/2006



1535 W 960 N  
Orem UT 84057  
Telephone/Fax  
(801) 222-0289

**\$5.00** (Refundable With  
First Purchase)